

Project	: ssis1220.dm1	
File Name	: ssis1220.dm1	
SubModel	: Main Model	
Author	: SSIS Project	
Company	: MN Dept of Human Services	
Version	: 12.2.0.0	Modified: 3/5/2012
Copyright (c)	2011 MN Dept of Human Services	

FISCAL_YR_CNTY_PREF (3230)

FY_CNTY_PREF_ID (PK)	NUMBER(10,0)	NOT NULL
FYCP_YEAR	NUMBER(4,0)	NULL
FYCP_ENCUMBER_IND	VARCHAR2(1)	NULL
MAX_EXC_WARN_IND	VARCHAR2(1)	NULL
FYCP_SIG_BDAY_CD	VARCHAR2(1)	NULL
FYCP_TOLERANCE_PCT	NUMBER(10,0)	NULL
FYCP_CLOSING_GL_DT	DATE	NULL
REQ_COA_MAX_IND	VARCHAR2(1)	NULL
LAST_CHGD_BY	NUMBER(10,0)	NOT NULL
LAST_CHGD_DT	DATE	NOT NULL

FISCAL_CONT_LANG (3240)

FISCAL_CONT_LANG_ID (PK)	NUMBER(10,0)	NOT NULL
FCL_TEXT	CLOB	NULL
FCL_DEFAULT_IND	VARCHAR2(1)	NULL
FCL_DESC	VARCHAR2(65)	NULL
FCL_TEXT2	CLOB	NULL
FCL_CNTY_DEF_IND	VARCHAR2(1)	NULL
LAST_CHGD_BY	NUMBER(10,0)	NOT NULL
LAST_CHGD_DT	DATE	NOT NULL

COA_ELEMENT_TYPE (2715)

COA_ELEMENT_TYPE_ID (PK)	NUMBER(10,0)	NOT NULL
COA_ELEM_TYPE_DESC	VARCHAR2(65)	NULL
ELEMENT_LENGTH	NUMBER(2,0)	NULL
ELEMENT_INDEX	NUMBER(2,0)	NULL
LAST_CHGD_BY	NUMBER(10,0)	NOT NULL
LAST_CHGD_DT	DATE	NOT NULL

SPECIAL_COST (3235)

SPECIAL_COST_ID (PK)	NUMBER(10,0)	NOT NULL
SPC_CODE	VARCHAR2(10)	NULL
SPC_DESC	VARCHAR2(100)	NULL
SPC_START_DT	DATE	NULL
SPC_END_DT	DATE	NULL
SPC_CNTY_DEF_IND	VARCHAR2(1)	NULL
LAST_CHGD_BY	NUMBER(10,0)	NOT NULL
LAST_CHGD_DT	DATE	NOT NULL

COA_GROUP_MAXIMUM (2720)

COA_GROUP_MAX_ID (PK)	NUMBER(10,0)	NOT NULL
CGM_MAX_AMOUNT	NUMBER(10,0)	NULL
CGM_START_DT	DATE	NULL
CGM_END_DT	DATE	NULL
CGM_DESC	VARCHAR2(100)	NULL
CGM_COMMENTS	CLOB	NULL
LAST_CHGD_BY	NUMBER(10,0)	NOT NULL
LAST_CHGD_DT	DATE	NOT NULL

COA_ELEMENT (2710)

COA_ELEMENT_ID (PK)	NUMBER(10,0)	NOT NULL
COA_ELEMENT_TYPE_ID (FK)	NUMBER(10,0)	NOT NULL
COA_ELEMENT_DESC	VARCHAR2(65)	NULL
START_DT	DATE	NULL
END_DT	DATE	NULL
COA_ELEM_COMMENTS	VARCHAR2(255)	NULL
COA_ELEMENT_VALUE	VARCHAR2(65)	NULL
LAST_CHGD_BY	NUMBER(10,0)	NOT NULL
LAST_CHGD_DT	DATE	NOT NULL

COA_CODE_MAXIMUM (2725)

COA_CODE_MAX_ID (PK)	NUMBER(10,0)	NOT NULL
COA_CODE_ID (FK)	NUMBER(10,0)	NULL
COA_GROUP_MAX_ID (FK)	NUMBER(10,0)	NULL
CCM_MAX_AMOUNT	NUMBER(10,0)	NULL
CCM_START_DT	DATE	NULL
CCM_END_DT	DATE	NULL
CCM_COMMENTS	CLOB	NULL
LAST_CHGD_BY	NUMBER(10,0)	NOT NULL
LAST_CHGD_DT	DATE	NOT NULL

COA_ELEMENT_XREF (2705)

COA_ELEMENT_XREF_ID (PK)	NUMBER(10,0)	NOT NULL
COA_CODE_ID (FK)	NUMBER(10,0)	NOT NULL
COA_ELEMENT_ID (FK)	NUMBER(10,0)	NOT NULL
LAST_CHGD_BY	NUMBER(10,0)	NOT NULL
LAST_CHGD_DT	DATE	NOT NULL

COA_CODE (2700)

COA_CODE_ID (PK)	NUMBER(10,0)	NOT NULL
COA_DESC	VARCHAR2(65)	NULL
START_DT	DATE	NULL
END_DT	DATE	NULL
COA_CODE_COMMENTS	VARCHAR2(255)	NULL
COA_REQ_MAX_IND	CHAR(1)	NULL
LAST_CHGD_BY	NUMBER(10,0)	NOT NULL
LAST_CHGD_DT	DATE	NOT NULL

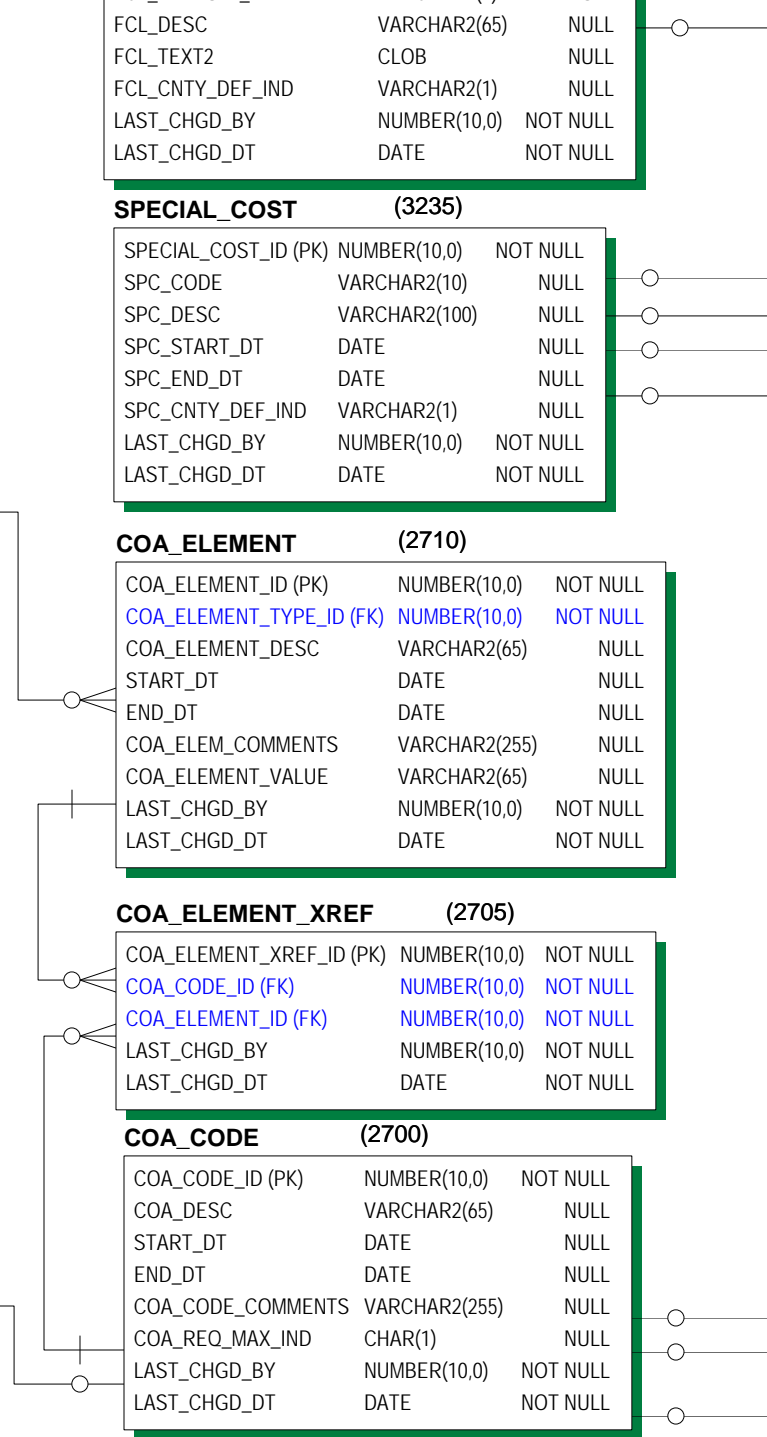

BRASS_PROGRAM (2800)

BRASS_PROGRAM_ID (PK)	NUMBER(10,0)	NOT NULL
BRASS_PROG_NUM	VARCHAR2(1)	NULL
BRASS_PROG_DESC	VARCHAR2(100)	NULL
LAST_CHGD_BY	NUMBER(10,0)	NOT NULL
LAST_CHGD_DT	DATE	NOT NULL

BRASS_SVC_CNTY_PREF (2805)

BSVC_CNTY_PREF_ID (PK)	NUMBER(10,0)	NOT NULL
BRASS_SVC_ID (FK)	NUMBER(10,0)	NOT NULL
STAFF_PROV_IND	CHAR(1)	NULL
VENDOR_PROV_IND	CHAR(1)	NULL
SUBSVC_REQ_IND	VARCHAR2(1)	NULL
LAST_CHGD_BY	NUMBER(10,0)	NOT NULL
LAST_CHGD_DT	DATE	NOT NULL

BRASS_SVC_HIST (2815)

BRASS_SVC_HIST_ID (PK)	NUMBER(10,0)	NOT NULL
BRASS_SVC_ID (FK)	NUMBER(10,0)	NOT NULL
BRASS_SVC_DESC	VARCHAR2(100)	NULL
STAFF_PROV_IND	CHAR(1)	NULL
VENDOR_PROV_IND	CHAR(1)	NULL
OVERRD_STAFFPROV_IND	VARCHAR2(1)	NULL
VALID_START_DT	DATE	NOT NULL
VALID_END_DT	DATE	NULL
UNIT_TYPE_CD	VARCHAR2(2)	NULL
CMHRS_IND	VARCHAR2(1)	NULL
LAST_CHGD_BY	NUMBER(10,0)	NOT NULL
LAST_CHGD_DT	DATE	NOT NULL

BRASS_SVC (2810)

BRASS_SVC_ID (PK)	NUMBER(10,0)	NOT NULL
BRASS_PROGRAM_ID (FK)	NUMBER(10,0)	NOT NULL
BRASS_SVC_NUM	VARCHAR2(2)	NULL
LAST_CHGD_BY	NUMBER(10,0)	NOT NULL
LAST_CHGD_DT	DATE	NOT NULL

CNTY_SUBSVC (2825)

CNTY_SUBSVC_ID (PK)	NUMBER(10,0)	NOT NULL
BRASS_SVC_ID (FK)	NUMBER(10,0)	NOT NULL
CNTY_SUBSVC_NUM	VARCHAR2(2)	NULL
CNTY_SUBSVC_DESC	VARCHAR2(100)	NULL
EFF_START_DT	DATE	NULL
EFF_END_DT	DATE	NULL
LAST_CHGD_BY	NUMBER(10,0)	NOT NULL
LAST_CHGD_DT	DATE	NOT NULL

BRASS_SVC_WG_TYPE (2820)

BRASS_SVC_WGTYPE_ID (PK)	NUMBER(10,0)	NOT NULL
BRASS_SVC_ID (FK)	NUMBER(10,0)	NOT NULL
WG_TYPE_CD	CHAR(1)	NULL
EFF_START_DT	DATE	NULL
EFF_END_DT	DATE	NULL
LAST_CHGD_BY	NUMBER(10,0)	NOT NULL
LAST_CHGD_DT	DATE	NOT NULL

VENDOR_SVC_HCPCS (1460)

SUBPROG_SVC_ID (PK)(FK)	NUMBER(10,0)	NOT NULL
HCPCS_CD (PK)(FK)	VARCHAR2(5)	NOT NULL
EFF_START_DT	DATE	NULL
EFF_END_DT	DATE	NULL
LAST_CHGD_BY	NUMBER(10,0)	NOT NULL
LAST_CHGD_DT	DATE	NOT NULL

SUBPROG_SVC (2830)

SUBPROG_SVC_ID (PK)	NUMBER(10,0)	NOT NULL
BRASS_SVC_ID (FK)	NUMBER(10,0)	NOT NULL
SUBPROG_ID (FK)	NUMBER(10,0)	NOT NULL
EFF_START_DT	DATE	NULL
EFF_END_DT	DATE	NULL
LAST_CHGD_BY	NUMBER(10,0)	NOT NULL
LAST_CHGD_DT	DATE	NOT NULL

SUBPROG (2840)

SUBPROG_ID (PK)	NUMBER(10,0)	NOT NULL
BRASS_PROGRAM_ID (FK)	NUMBER(10,0)	NOT NULL
SUBPROG_NUM	VARCHAR2(2)	NULL
SUBPROG_ABBR	VARCHAR2(5)	NULL
SUBPROG_DESC	VARCHAR2(100)	NULL
EFF_START_DT	DATE	NULL
EFF_END_DT	DATE	NULL
LAST_CHGD_BY	NUMBER(10,0)	NOT NULL
LAST_CHGD_DT	DATE	NOT NULL

SUBPROG_SVC_ACT (2845)

SUBPROG_SVC_ACT_ID (PK)	NUMBER(10,0)	NOT NULL
SUBPROG_SVC_ID (FK)	NUMBER(10,0)	NOT NULL
TR_ACTIVITY_ID (FK)	NUMBER(10,0)	NOT NULL
LAST_CHGD_BY	NUMBER(10,0)	NOT NULL
LAST_CHGD_DT	DATE	NOT NULL

BUS_ORG_WSP_XREF (2365)

BUS_ORG_WSP_XREF_ID (PK)	NUMBER(10,0)	NOT NULL
BUS_ORG_ID (FK)	NUMBER(10,0)	NULL
WILL_SERVE_PREFS_ID (FK)	NUMBER(10,0)	NOT NULL
DEFAULT_WSP_IND	VARCHAR2(1)	NULL
LAST_CHGD_BY	NUMBER(10,0)	NOT NULL
LAST_CHGD_DT	DATE	NOT NULL

WILL_SERVE_PREFS (2360)

WILL_SERVE_PREFS_ID (PK)	NUMBER(10,0)	NOT NULL
GENDER_WILL_SRV_CD	CHAR(1)	NULL
MAX_AGE_WILL_SRV	NUMBER(3,0)	NULL
MIN_AGE_WILL_SRV	NUMBER(3,0)	NULL
PREF_CLIENTS_CD	CHAR(1)	NULL
LAST_CHGD_BY	NUMBER(10,0)	NOT NULL
LAST_CHGD_DT	DATE	NOT NULL

BUS_ORG_TYPE (2340)

BUS_ORG_TYPE_ID (PK)	NUMBER(10,0)	NOT NULL
DESCRIPTION	VARCHAR2(65)	NULL
LAST_CHGD_BY	NUMBER(10,0)	NOT NULL
LAST_CHGD_DT	DATE	NOT NULL

BUS_ORG_SVC (2350)

BUS_ORG_SVC_ID (PK)	NUMBER(10,0)	NOT NULL
BUS_ORG_ID (FK)	NUMBER(10,0)	NOT NULL
BRASS_SVC_ID (FK)	NUMBER(10,0)	NOT NULL
WILL_SERVE_PREFS_ID (FK)	NUMBER(10,0)	NULL
DEFAULT_1099_CD	VARCHAR2(1)	NULL
LAST_CHGD_BY	NUMBER(10,0)	NOT NULL
LAST_CHGD_DT	DATE	NOT NULL

BUS_ORG_PHONE_XREF (2310)

BUS_ORG_PHONE_ID (PK)	NUMBER(10,0)	NOT NULL
BUS_ORG_ID (FK)	NUMBER(10,0)	NOT NULL
PHONE_ID (FK)	NUMBER(10,0)	NOT NULL
PHONE_TYPE_CD	CHAR(1)	NULL
LAST_CHGD_BY	NUMBER(10,0)	NOT NULL
LAST_CHGD_DT	DATE	NOT NULL

BUS_ORG_SUBSVC (2355)

BUS_ORG_SUBSVC_ID (PK)	NUMBER(10,0)	NOT NULL
BUS_ORG_SVC_ID (FK)	NUMBER(10,0)	NOT NULL
CNTY_SUBSVC_ID (FK)	NUMBER(10,0)	NOT NULL
LAST_CHGD_BY	NUMBER(10,0)	NOT NULL
LAST_CHGD_DT	DATE	NOT NULL

BUS_ORG_ADDR_XREF (2315)

BUS_ORG_ADDR_ID (PK)	NUMBER(10,0)	NOT NULL
BUS_ORG_ID (FK)	NUMBER(10,0)	NOT NULL
ADDRESS_ID (FK)	NUMBER(10,0)	NOT NULL
ADDR_TYPE_CD	CHAR(1)	NOT NULL
START_DT	DATE	NOT NULL
END_DT	DATE	NULL
CARE_OF_LINE	VARCHAR2(40)	NULL
LAST_CHGD_BY	NUMBER(10,0)	NOT NULL
LAST_CHGD_DT	DATE	NOT NULL

BUS_ORG (2300)

BUS_ORG_ID (PK)	NUMBER(10,0)	NOT NULL
BUS_NAME	VARCHAR2(50)	NULL
BUS_ORG_DESC	VARCHAR2(250)	NULL
BUS_ORG_TYPE_ID (FK)	NUMBER(10,0)	NULL
CNTY_PROV_NUM	VARCHAR2(20)	NULL
MMIS_PROV_NUM	VARCHAR2(10)	NULL
FED_TID	VARCHAR2(9)	NULL
BUS_ORG_STATUS_CD	VARCHAR2(1)	NULL
BUS_ORG_STATUS_DT	DATE	NULL
VOUCHER_METH_CD	VARCHAR2(1)	NULL
DEFAULT_1099_CD	VARCHAR2(1)	NULL
NPI	VARCHAR2(10)	NULL
LAST_CHGD_BY	NUMBER(10,0)	NOT NULL
LAST_CHGD_DT	DATE	NOT NULL

BUS_ORG_RELATION (2385)

BUS_ORG_RELATION_ID (PK)	NUMBER(10,0)	NOT NULL
BUS_ORG_REL_DESC	VARCHAR2(100)	NULL
BUS_ORG_REL_DESC2	VARCHAR2(100)	NULL
LAST_CHGD_BY	NUMBER(10,0)	NOT NULL
LAST_CHGD_DT	DATE	NOT NULL

BUS_ORG_XREF (2380)

BUS_ORG_XREF_ID (PK)	NUMBER(10,0)	NOT NULL
BUS_ORG_ID (FK)	NUMBER(10,0)	NOT NULL
BUS_ORG_ID2 (FK)	NUMBER(10,0)	NOT NULL
BUS_ORG_RELATION_ID (FK)	NUMBER(10,0)	NOT NULL
LAST_CHGD_BY	NUMBER(10,0)	NOT NULL
LAST_CHGD_DT	DATE	NOT NULL

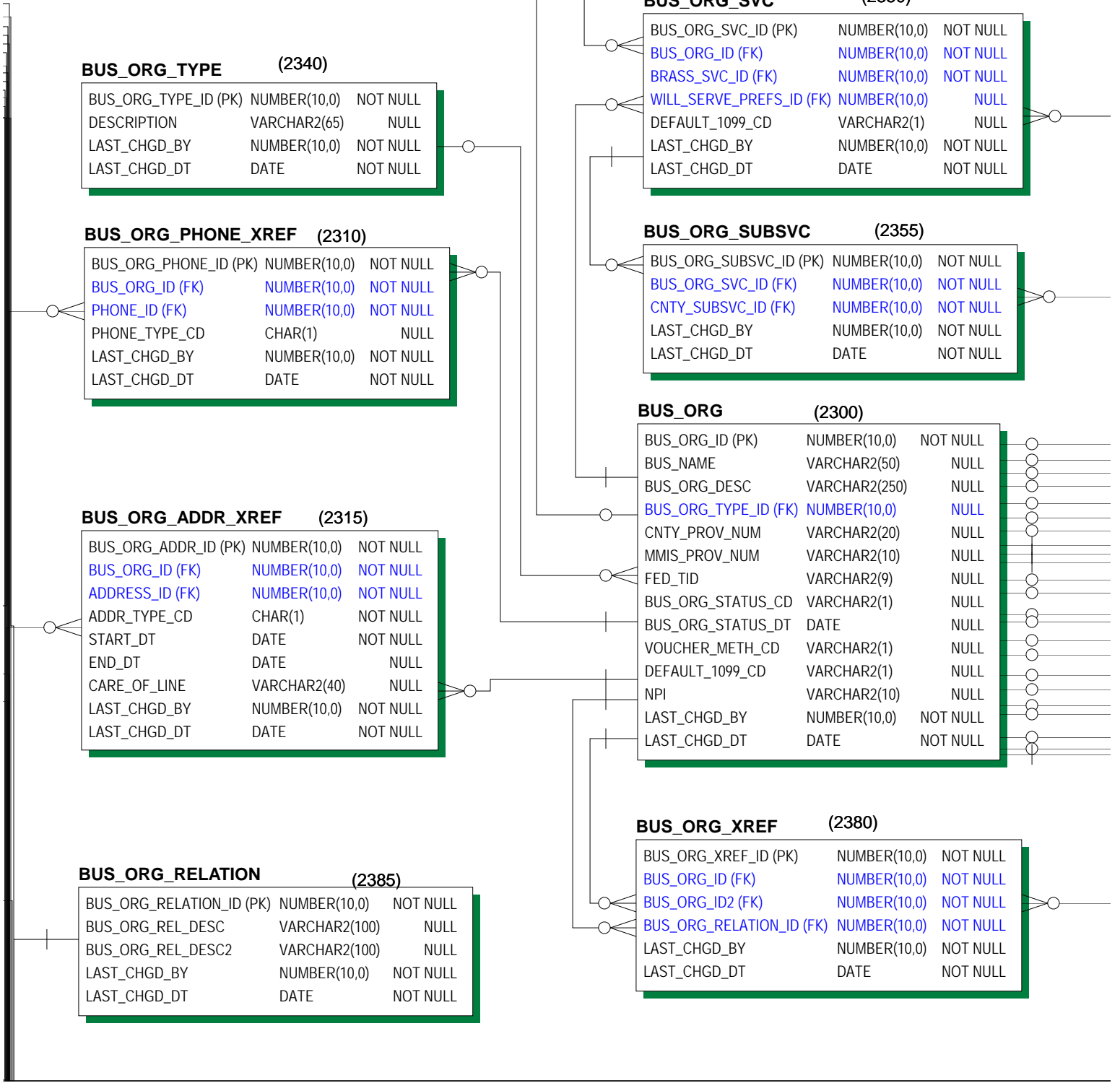

DI_CHILD_ELIG (2500)		
DI_CHILD_ELIG_ID (PK)	NUMBER(10,0)	NOT NULL
DATA_TYPE	VARCHAR2(4)	NOT NULL
PMI	VARCHAR2(10)	NULL
OLD_PMI	VARCHAR2(10)	NULL
PERSON_ID (FK)	NUMBER(10,0)	NULL
SSN	VARCHAR2(9)	NULL
FIRST_NAME	VARCHAR2(20)	NULL
MIDDLE_INIT	CHAR(1)	NULL
LAST_NAME	VARCHAR2(30)	NULL
NAME_SUFFIX	VARCHAR2(5)	NULL
BIRTH_DT	DATE	NULL
GENDER_CD	CHAR(1)	NULL
PETITION_DT	DATE	NULL
DEPR_FACTOR_CD	CHAR(2)	NULL
REASONABLE_EFF_CD	CHAR(1)	NULL
AFDC_CHILD_IND	CHAR(1)	NULL
AFDC_BASIS_IND	CHAR(1)	NULL
AFDC_VERIFY_IND	CHAR(1)	NULL
ASSET_LIMIT_IND	CHAR(1)	NULL
BEST_INTEREST_DT	DATE	NULL
BEST_INTEREST_IND	CHAR(1)	NULL
CITIZENSHIP_IND	CHAR(1)	NULL
LEGAL_RESP_IND	CHAR(1)	NULL
GROSS_INCOME_IND	CHAR(1)	NULL
NET_INCOME_IND	CHAR(1)	NULL
REASONABLE_EFF_DT	DATE	NULL
REASONABLE_EFF_IND	CHAR(1)	NULL
REL_GUARD_IND	CHAR(1)	NULL
ELIG_BEGIN_DT	DATE	NULL
ELIG_END_DT	DATE	NULL
CNTY_OF_SVC_CD	CHAR(2)	NULL
OLD_CNTY_OF_SVC_CD	CHAR(2)	NULL
VOL_PLCMT_AGRMT_DT	DATE	NULL
COURT_HEARING_DT	DATE	NULL
TIMESTAMP_DT	DATE	NULL
SMI_ID	NUMBER(10,0)	NULL
CONTPLCMT_ID (FK)	NUMBER(10,0)	NULL
CONTPLCMT_START_DT	DATE	NULL
MAXIS_CASE_NUM	VARCHAR2(8)	NULL
OLD_MAXIS_CASE_NUM	VARCHAR2(8)	NULL
GRAD_YR_MONTH	VARCHAR2(6)	NULL
STUDENT_STAT_CD	CHAR(1)	NULL
ASSET_TRANSF_IND	VARCHAR2(1)	NULL
STRIKE_IND	VARCHAR2(1)	NULL
APPL_WTHDRN_IND	VARCHAR2(1)	NULL
COOPR_IND	VARCHAR2(1)	NULL
DECEASED_IND	VARCHAR2(1)	NULL
NEXT_MAXIS_RVW_DT	DATE	NULL
MAXIS_WKR_FIRST_NAME	VARCHAR2(14)	NULL
MAXIS_WKR_LAST_NAME	VARCHAR2(20)	NULL
BENEFIT_YR_MONTH	VARCHAR2(6)	NULL
TRANSFER_LEGAL_DT	DATE	NULL
LAST_CHGD_BY	NUMBER(10,0)	NOT NULL
LAST_CHGD_DT	DATE	NOT NULL

DI_CHLD_MNTH_RMB (2505)		
DI_CHLD_MNTH_RMB_ID (PK)	NUMBER(10,0)	NOT NULL
PMI	VARCHAR2(10)	NULL
PERSON_ID (FK)	NUMBER(10,0)	NULL
SSN	VARCHAR2(9)	NULL
FIRST_NAME	VARCHAR2(20)	NULL
MIDDLE_INIT	CHAR(1)	NULL
LAST_NAME	VARCHAR2(30)	NULL
NAME_SUFFIX	VARCHAR2(5)	NULL
BIRTH_DT	DATE	NULL
GENDER_CD	CHAR(1)	NULL
ENTERED_FC_DT	DATE	NULL
AFDC_BASIS_IND	CHAR(1)	NULL
AFDC_VERIFY_IND	CHAR(1)	NULL
ASSET_LIMIT_IND	CHAR(1)	NULL
GROSS_INCOME_IND	CHAR(1)	NULL
NET_INCOME_IND	CHAR(1)	NULL
DEPR_FACTOR_CD	CHAR(2)	NULL
DUP_ASSISTANCE_IND	CHAR(1)	NULL
REAS_EFF_PERM_DT	DATE	NULL
REAS_EFF_PERM_IND	CHAR(1)	NULL
GRAD_YR_MONTH	VARCHAR2(6)	NULL
STUDENT_STAT_CD	CHAR(1)	NULL
REIMB_YR_MONTH	VARCHAR2(6)	NULL
VOL_PLCMT_AGRMT_DT	DATE	NULL
COURT_HEARING_DT	DATE	NULL
CNTY_OF_SVC_CD	CHAR(2)	NULL
TIMESTAMP_DT	DATE	NULL
SMI_ID	NUMBER(10,0)	NULL
CONTPLCMT_ID (FK)	NUMBER(10,0)	NULL
CONTPLCMT_START_DT	DATE	NULL
MAXIS_CASE_NUM	VARCHAR2(8)	NULL
OLD_MAXIS_CASE_NUM	VARCHAR2(8)	NULL
SUP_AGCY_CD	VARCHAR2(1)	NULL
IVE_MNT_AGR_EFF_DT	DATE	NULL
IVE_MNT_AGR_END_DT	DATE	NULL
UMBRELLA_CO_IND	VARCHAR2(1)	NULL
COOPR_IND	VARCHAR2(1)	NULL
IVE_MNT_AGR_IND	VARCHAR2(1)	NULL
LUMP_SUM_IND	VARCHAR2(1)	NULL
REVIEW_CERT_IND	VARCHAR2(1)	NULL
NEXT_MAXIS_RVW_DT	DATE	NULL
MAXIS_WKR_FIRST_NAME	VARCHAR2(14)	NULL
MAXIS_WKR_LAST_NAME	VARCHAR2(20)	NULL
TRANSFER_LEGAL_DT	DATE	NULL
LAST_CHGD_BY	NUMBER(10,0)	NOT NULL
LAST_CHGD_DT	DATE	NOT NULL

DI_IVE_RMB_WKS (3700)		
DI_IVE_RMB_WKS_ID (PK)	NUMBER(10,0)	NOT NULL
CONTPLCMT_ID (FK)	NUMBER(10,0)	NOT NULL
CHIPS_DT	DATE	NULL
CHIPS_IND	VARCHAR2(1)	NULL
LAST_CHGD_BY	NUMBER(10,0)	NOT NULL
LAST_CHGD_DT	DATE	NOT NULL

ELIG_CWTCM (3400)

ELIG_CWTCM_ID (PK)	NUMBER(10,0)	NOT NULL
PERSON_ID (FK)	NUMBER(10,0)	NOT NULL
WG_ID (FK)	NUMBER(10,0)	NULL
CWTCM_MALT_DT	DATE	NULL
CWTCM_PLCMT_DT	DATE	NULL
CWTCM_PROTECT_DT	DATE	NULL
CWTCM_SVC_PLAN_DT	DATE	NULL
DET_FACT_START_DT	DATE	NULL
DET_FACT_END_DT	DATE	NULL
PLAN_TYPE_CD	CHAR(1)	NULL
TEFRA_OVER_START_DT	DATE	NULL
TEFRA_OVER_END_DT	DATE	NULL
CWTCM_PLAN_COMMENT	CLOB	NULL
LAST_CHGD_BY	NUMBER(10,0)	NOT NULL
LAST_CHGD_DT	DATE	NOT NULL

ELIG_MHTCM (3410)

ELIG_MHTCM_ID (PK)	NUMBER(10,0)	NOT NULL
PERSON_ID (FK)	NUMBER(10,0)	NOT NULL
WG_ID (FK)	NUMBER(10,0)	NULL
MHTCM_START_DT	DATE	NULL
MHTCM_END_DT	DATE	NULL
LAST_CHGD_BY	NUMBER(10,0)	NOT NULL
LAST_CHGD_DT	DATE	NOT NULL

ELIG_VADDTCM (3415)

ELIG_VADDTCM_ID (PK)	NUMBER(10,0)	NOT NULL
PERSON_ID (FK)	NUMBER(10,0)	NOT NULL
WG_ID (FK)	NUMBER(10,0)	NULL
VADD_START_DT	DATE	NULL
VADD_END_DT	DATE	NULL
LAST_CHGD_BY	NUMBER(10,0)	NOT NULL
LAST_CHGD_DT	DATE	NOT NULL

ELIG_RULE5 (3420)

ELIG_RULE5_ID (PK)	NUMBER(10,0)	NOT NULL
PERSON_ID (FK)	NUMBER(10,0)	NOT NULL
WG_ID (FK)	NUMBER(10,0)	NULL
MH_RULE5_CARE_IND	VARCHAR2(1)	NULL
MH_RULE5_END_DT	DATE	NULL
MH_RULE5_SCRNG_DT	DATE	NULL
LAST_CHGD_BY	NUMBER(10,0)	NOT NULL
LAST_CHGD_DT	DATE	NOT NULL

DI_IVE_ELIG_WKS (3710)

DI_IVE_ELIG_WKS_ID (PK)	NUMBER(10,0)	NOT NULL
CONTPLCMT_ID (FK)	NUMBER(10,0)	NOT NULL
NOT_SEEKING_IVE_CD	VARCHAR2(1)	NULL
PET_COURT_DETAIL_ID (FK)	NUMBER(10,0)	NULL
CT_COURT_DETAIL_ID (FK)	NUMBER(10,0)	NULL
BI_COURT_DETAIL_ID (FK)	NUMBER(10,0)	NULL
BEST_INTEREST_IND	CHAR(1)	NULL
REA_COURT_DETAIL_ID (FK)	NUMBER(10,0)	NULL
REASONABLE_EFF_IND	CHAR(1)	NULL
IVE_RMV_DT	DATE	NULL
LAST_CHGD_BY	NUMBER(10,0)	NOT NULL
LAST_CHGD_DT	DATE	NOT NULL

ELIG_CWTCM_REVIEW (3405)

ELIG_CWTCM_REVIEW_ID (PK)	NUMBER(10,0)	NOT NULL
ELIG_CWTCM_ID (FK)	NUMBER(10,0)	NOT NULL
CWTCM_REVIEW_DT	DATE	NULL
PLAN_TYPE_CD	CHAR(1)	NULL
SVC_PLAN_DT	DATE	NULL
LAST_CHGD_BY	NUMBER(10,0)	NOT NULL
LAST_CHGD_DT	DATE	NOT NULL

DI_ELIG_PPHP_DATA (3465)

DI_ELIG_PPHP_DATA_ID (PK)	NUMBER(10,0)	NOT NULL
DI_ELIG_MMIS_ID (FK)	NUMBER(10,0)	NOT NULL
PPHP_START_DT	DATE	NULL
PPHP_END_DT	DATE	NULL
PPHP_CONTRACT	VARCHAR2(20)	NULL
PPHP_PROV_NAME	VARCHAR2(50)	NULL
PROV_CNTY_CD	VARCHAR2(3)	NULL
NPI	VARCHAR2(10)	NULL
LAST_CHGD_BY	NUMBER(10,0)	NOT NULL
LAST_CHGD_DT	DATE	NOT NULL

DI_ELIG_LIVE_ARR (3460)

DI_ELIG_LIVE_ARR_ID (PK)	NUMBER(10,0)	NOT NULL
DI_ELIG_MMIS_ID (FK)	NUMBER(10,0)	NOT NULL
FACILITY_NAME	VARCHAR2(40)	NULL
LIVE_ARR_CD	CHAR(2)	NULL
LIVE_ARR_START_DT	DATE	NULL
LIVE_ARR_END_DT	DATE	NULL
OUT_HOME_PROV_NUM	VARCHAR2(20)	NULL
PROV_CNTY_CD	VARCHAR2(3)	NULL
NPI	VARCHAR2(10)	NULL
LAST_CHGD_BY	NUMBER(10,0)	NOT NULL
LAST_CHGD_DT	DATE	NOT NULL

DI_ELIG_DTH_DATA (3455)

DI_ELIG_DTH_DATA_ID (PK)	NUMBER(10,0)	NOT NULL
DI_ELIG_MMIS_ID (FK)	NUMBER(10,0)	NOT NULL
DTH_START_DT	DATE	NULL
DTH_END_DT	DATE	NULL
DTH_SERVICE_CD	VARCHAR2(1)	NULL
LAST_CHGD_BY	NUMBER(10,0)	NOT NULL
LAST_CHGD_DT	DATE	NOT NULL

DI_ELIG_WAIVER (3475)

DI_ELIG_WAIVER_ID (PK)	NUMBER(10,0)	NOT NULL
DI_ELIG_MMIS_ID (FK)	NUMBER(10,0)	NOT NULL
WAIVER_START_DT	DATE	NULL
WAIVER_SCREEN_DT	DATE	NULL
WAIVER_THRU_DT	DATE	NULL
WAIVER_TYPE_CD	VARCHAR2(1)	NULL
LAST_CHGD_BY	NUMBER(10,0)	NOT NULL
LAST_CHGD_DT	DATE	NOT NULL

DI_ELIG_RECIPIENT (3470)

DI_ELIG_RECIPIENT_ID (PK)	NUMBER(10,0)	NOT NULL
DI_ELIG_MMIS_ID (FK)	NUMBER(10,0)	NOT NULL
CNTY_OF_FIN_RESP_CD	VARCHAR2(3)	NULL
ELIG_END_DT	DATE	NULL
ELIG_TYPE_CD	VARCHAR2(2)	NOT NULL
EXTRACT_DT	DATE	NOT NULL
MAJOR_PROG_CD	VARCHAR2(2)	NOT NULL
RCP_ELIG_STATUS_CD	VARCHAR2(1)	NOT NULL
ELIG_START_DT	DATE	NULL
LAST_CHGD_BY	NUMBER(10,0)	NOT NULL
LAST_CHGD_DT	DATE	NOT NULL

DI_ELIG_MMIS (3425)

DI_ELIG_MMIS_ID (PK)	NUMBER(10,0)	NOT NULL
WG_ID (FK)	NUMBER(10,0)	NULL
CNTY_OF_RES_CD	VARCHAR2(3)	NULL
CNTY_OF_SERVICE_CD	VARCHAR2(3)	NULL
MMIS_UPDATE_DT	DATE	NULL
PMI	VARCHAR2(10)	NOT NULL
RCP_BIRTH_DT	DATE	NULL
RCP_FIRST_NAME	VARCHAR2(30)	NULL
RCP_GENDER_CD	VARCHAR2(1)	NULL
RCP_LAST_NAME	VARCHAR2(30)	NULL
RCP_MIDDLE_INITIAL	VARCHAR2(1)	NULL
RCP_SSN	VARCHAR2(9)	NULL
TPL_IND	VARCHAR2(1)	NULL
ELIG_START_DT	DATE	NULL
ELIG_END_DT	DATE	NULL
LAST_CHGD_BY	NUMBER(10,0)	NOT NULL
LAST_CHGD_DT	DATE	NOT NULL

DI_ELIG_LTC_SCRNG (3440)

DI_ELIG_LTC_SCRNG_ID (PK)	NUMBER(10,0)	NOT NULL
DI_ELIG_MMIS_ID (FK)	NUMBER(10,0)	NOT NULL
ASSESSMENT_DT	DATE	NULL
CDCS_AMT	NUMBER(12,2)	NULL
CDCS_IND	VARCHAR2(1)	NULL
CREATED_DT	DATE	NULL
LTC_ASSES_EXIT1_CD	VARCHAR2(2)	NULL
LTC_ASSES_EXIT2_CD	VARCHAR2(2)	NULL
LTC_WAIVER_TYPE_CD	VARCHAR2(2)	NULL
PA_SCRNG_STATUS_CD	VARCHAR2(1)	NULL
PRIOR_AUTH_NUM	NUMBER(11,0)	NULL
SCRNG_ACT_TYPE_CD	VARCHAR2(2)	NULL
SCRNG_ACT_TYPE_DT	DATE	NULL
LAST_CHGD_BY	NUMBER(10,0)	NOT NULL
LAST_CHGD_DT	DATE	NOT NULL

DI_ELIG_SA_LN_ITM (3480)

DI_ELIG_SA_LN_ITM_ID (PK)	NUMBER(10,0)	NOT NULL
DI_ELIG_SA_ID (FK)	NUMBER(10,0)	NOT NULL
PA_AMT_REQUEST	NUMBER(12,2)	NULL
PA_AMT_USED	NUMBER(12,2)	NULL
PA_LINE_START_DT	DATE	NULL
PA_LINE_END_DT	DATE	NULL
PA_RATE_PER_UNIT	NUMBER(12,2)	NULL
PA_UNITS_REQUEST	NUMBER(9,3)	NULL
PA_UNITS_USED	NUMBER(9,3)	NULL
HCPCS_CD	VARCHAR2(5)	NULL
MOD_1	VARCHAR2(2)	NULL
MOD_2	VARCHAR2(2)	NULL
MOD_3	VARCHAR2(2)	NULL
MOD_4	VARCHAR2(2)	NULL
PROV_NUM	VARCHAR2(20)	NULL
SA_LINE_STATUS_CD	VARCHAR2(1)	NULL
SERVICE_FREQ	VARCHAR2(1)	NULL
PRIOR_AUTH_LINE_NUM	NUMBER(2,0)	NULL
NPI	VARCHAR2(10)	NULL
LAST_CHGD_BY	NUMBER(10,0)	NOT NULL
LAST_CHGD_DT	DATE	NOT NULL

DI_ELIG_SA (3485)

DI_ELIG_SA_ID (PK)	NUMBER(10,0)	NOT NULL
DI_ELIG_MMIS_ID (FK)	NUMBER(10,0)	NOT NULL
CREATED_DT	DATE	NULL
EXCLUDED_TIME_IND	VARCHAR2(1)	NULL
EXT_TOT_AMT_USED	NUMBER(12,2)	NULL
EXT_TOT_UNITS_USED	NUMBER(10,3)	NULL
PA_TOTAL_CAP_AMT	NUMBER(12,2)	NULL
PRIOR_AUTH_NUM	NUMBER(11,0)	NULL
SA_START_DT	DATE	NULL
SA_END_DT	DATE	NULL
SA_TYPE_CD	VARCHAR2(1)	NULL
PA_STATUS_REASON1_CD	VARCHAR2(3)	NULL
PA_STATUS_REASON2_CD	VARCHAR2(3)	NULL
PA_STATUS_REASON3_CD	VARCHAR2(3)	NULL
SA_HDR_STATUS_CD	VARCHAR2(1)	NULL
LAST_CHGD_BY	NUMBER(10,0)	NOT NULL
LAST_CHGD_DT	DATE	NOT NULL

DI_ELIG_DD_SCRNG (3450)

DI_ELIG_DD_SCRNG_ID (PK)	NUMBER(10,0)	NOT NULL
DI_ELIG_MMIS_ID (FK)	NUMBER(10,0)	NOT NULL
ACTION_DT	DATE	NULL
ACTION_TYPE_CD	VARCHAR2(2)	NULL
CREATED_DT	DATE	NULL
PA_SCRNG_STATUS_CD	VARCHAR2(1)	NULL
PRIOR_AUTH_NUM	NUMBER(11,0)	NULL
LAST_CHGD_BY	NUMBER(10,0)	NOT NULL
LAST_CHGD_DT	DATE	NOT NULL

DI_ELIG_DD_DIAG (3445)

DI_ELIG_DD_DIAG_ID (PK)	NUMBER(10,0)	NOT NULL
DI_ELIG_DD_SCRNG_ID (FK)	NUMBER(10,0)	NOT NULL
DIAGNOSIS_CD	VARCHAR2(6)	NOT NULL
DIAG_INDEX	NUMBER(10,0)	NOT NULL
LAST_CHGD_BY	NUMBER(10,0)	NOT NULL
LAST_CHGD_DT	DATE	NOT NULL

PLACEMENTREVIEWS

FORMATTED_PERSON	VARCHAR2(80)	NULL
CONTPLCMT_START_DT	DATE	NULL
CONTPLCMT_END_DT	DATE	NULL
REVIEW_TYPE_DESC	VARCHAR2(65)	NULL
LAST_REVIEW_DT	DATE	NULL
NEXT_REVIEW_DT	DATE	NOT NULL
FORMATTED_WORKER	VARCHAR2(80)	NULL

PROOFING_REPOSITORY

ID	NUMBER(10,0)	NULL
IMAGENUM	NUMBER(10,0)	NULL
GROUP_CAPTION	VARCHAR2(100)	NULL
CP_CAPTION	VARCHAR2(400)	NULL
CP_DESCRIPTION	VARCHAR2(4000)	NULL
PATH	VARCHAR2(500)	NULL
ERROR_LINK_ID	NUMBER(10,0)	NULL

ID_MULTISELECT

ID	NUMBER(10,0)	NULL
----	--------------	------

TT_RPT_MALT_FACI_SUM

ABUSE_CD	VARCHAR2(6)	NOT NULL
ABUSE_DESC	VARCHAR2(65)	NULL
I_TOTAL	NUMBER(10,0)	NULL
C_TOTAL	NUMBER(10,0)	NULL
I_PENDING	NUMBER(10,0)	NULL
C_PENDING	NUMBER(10,0)	NULL
I_UN_TO_COMP	NUMBER(10,0)	NULL
C_UN_TO_COMP	NUMBER(10,0)	NULL
I_MALT_DERM_Y	NUMBER(10,0)	NULL
C_MALT_DERM_Y	NUMBER(10,0)	NULL
I_MALT_DERM_N	NUMBER(10,0)	NULL
C_MALT_DERM_N	NUMBER(10,0)	NULL
I_CPS_NEEDED_Y	NUMBER(10,0)	NULL
C_CPS_NEEDED_Y	NUMBER(10,0)	NULL
I_CPS_NEEDED_N	NUMBER(10,0)	NULL
C_CPS_NEEDED_N	NUMBER(10,0)	NULL
I_FAC_RESP_Y	NUMBER(10,0)	NULL
C_FAC_RESP_Y	NUMBER(10,0)	NULL
I_FAC_RESP_N	NUMBER(10,0)	NULL
C_FAC_RESP_N	NUMBER(10,0)	NULL
I_FAC_STAFF_RESP_Y	NUMBER(10,0)	NULL
C_FAC_STAFF_RESP_Y	NUMBER(10,0)	NULL
I_FAC_STAFF_RESP_N	NUMBER(10,0)	NULL
C_FAC_STAFF_RESP_N	NUMBER(10,0)	NULL
I_CPS_NOTNEEDED_NA	NUMBER(10,0)	NULL
C_CPS_NOTNEEDED_NA	NUMBER(10,0)	NULL
I_CPS_NOTNEEDED_UA	NUMBER(10,0)	NULL
C_CPS_NOTNEEDED_UA	NUMBER(10,0)	NULL
UNIT_ID	NUMBER(10,0)	NULL
DEPT_ID	NUMBER(10,0)	NULL
UNIT_NAME	VARCHAR2(50)	NULL
DEPARTMENT_NAME	VARCHAR2(50)	NULL
REPORT_COUNT	NUMBER(10,0)	NULL

PERSON_MULTISELECT

COUNTY_CLEARED	NUMBER	NULL
COUNTY_DETAIL	NUMBER	NULL
STATE_DETAIL	NUMBER	NULL
SW_INDEX_ID	NUMBER(10,0)	NULL
GENDER_CD	CHAR(1)	NULL
BIRTH_DT	DATE	NULL
SSN	VARCHAR2(9)	NULL
LAST_NAME	VARCHAR2(30)	NULL
FIRST_NAME	VARCHAR2(20)	NULL
MIDDLE_NAME	VARCHAR2(20)	NULL
NAME_SUFFIX	VARCHAR2(5)	NULL
ADDR_1	VARCHAR2(100)	NULL
ADDR_2	VARCHAR2(100)	NULL
ADDR_3	VARCHAR2(100)	NULL
CITY	VARCHAR2(25)	NULL
FOREIGN_STATE_PROV	VARCHAR2(20)	NULL
FOREIGN_POST_CODE	VARCHAR2(20)	NULL
STATE_CD	CHAR(2)	NULL
ZIP_CODE	CHAR(5)	NULL
ZIP_CODE_EXT	VARCHAR2(4)	NULL
COUNTRY	VARCHAR2(30)	NULL
PERSON_ID	NUMBER(10,0)	NULL
ALIAS_NAME_ID	NUMBER(10,0)	NULL
CNTY_PERSON_NUM	VARCHAR2(10)	NULL
NAME_TYPE_CD	CHAR(1)	NULL
PMI	VARCHAR2(10)	NULL
DECEASED_DT	DATE	NULL

TT_RPT_MALT_DISP_SUM

UNIT_ID	NUMBER(10,0)	NOT NULL
UNIT_NAME	VARCHAR2(50)	NULL
DEPT_ID	NUMBER(10,0)	NULL
DEPARTMENT_NAME	VARCHAR2(50)	NULL
TRACK_CD	VARCHAR2(1)	NULL
TRACK_DESC	VARCHAR2(50)	NULL
DISP_DESC	VARCHAR2(80)	NULL
DISP_COUNT	NUMBER(10,0)	NULL
CASES_FI_COUNT	NUMBER(10,0)	NULL
CASES_FA_COUNT	NUMBER(10,0)	NULL
CASES_FI_FA_COUNT	NUMBER(10,0)	NULL

TIME_TO_INIT_CONTACT

WG_ID	NUMBER(10,0)	NULL
DEPARTMENT_NAME	VARCHAR2(50)	NULL
UNIT_NAME	VARCHAR2(50)	NULL
WORKER_NAME	VARCHAR2(80)	NULL
WG_LABEL	VARCHAR2(80)	NULL
INIT_TRACK	VARCHAR2(3)	NULL
CURR_TRACK	VARCHAR2(3)	NULL
INTAKE_DT	DATE	NULL
DISP_DT	DATE	NULL
CP_RPT_END_DT	DATE	NULL
VIC_CONT_PT	VARCHAR2(20)	NULL
VIC_CONT_HRS	NUMBER(10,0)	NULL
OTHER_CONT_DT	DATE	NULL
OTHER_CONT_HRS	NUMBER(10,0)	NULL
SUB_ENDANGERMENT_IND	VARCHAR2(1)	NULL

SVC_ARRANGEMENT (3200)

SVC_ARRANGEMENT_ID (PK)	NUMBER(10,0)	NOT NULL
SA_AGREEMENT_ID (FK)	NUMBER(10,0)	NULL
SA_GROUP_ID (FK)	NUMBER(10,0)	NULL
SUBPROG_ID (FK)	NUMBER(10,0)	NULL
BRASS_SVC_ID (FK)	NUMBER(10,0)	NULL
CNTY_SUBSVC_ID (FK)	NUMBER(10,0)	NULL
BUS_ORG_ID (FK)	NUMBER(10,0)	NULL
PAYEE_BUS_ORG_ID (FK)	NUMBER(10,0)	NULL
COA_CODE_ID (FK)	NUMBER(10,0)	NULL
STAFF_ID (FK)	NUMBER(10,0)	NULL
PERSON_ID (FK)	NUMBER(10,0)	NULL
HCPCS_MOD_ID (FK)	NUMBER(10,0)	NULL
SPECIAL_COST_ID (FK)	NUMBER(10,0)	NULL
WG_ID (FK)	NUMBER(10,0)	NULL
CONTACT_LOC_CD	CHAR(1)	NULL
DEFAULT_1099_CD	VARCHAR2(1)	NULL
CONTRACT_NUM	VARCHAR2(20)	NULL
PAY_CLIENT_SPEC_IND	VARCHAR2(1)	NULL
PREPRTD_VOUCHER_IND	VARCHAR2(1)	NULL
REMIT_ADV_DESC	VARCHAR2(255)	NULL
SA_DESC	VARCHAR2(100)	NULL
SA_DOCPTS	NUMBER(10,0)	NULL
SA_PAYING_CNTY_CD	VARCHAR2(2)	NULL
SA_PER_DIEM	NUMBER(12,2)	NULL
SA_RATE	NUMBER(14,4)	NULL
SA_START_DT	DATE	NULL
SA_END_DT	DATE	NULL
UNIT_TYPE_CD	VARCHAR2(2)	NULL
SA_STATUS_CD	VARCHAR2(2)	NULL
SA_ENTRY_DT	DATE	NULL
IVE_REIMB_IND	VARCHAR2(1)	NULL
PROV_LIC_NUM	VARCHAR2(10)	NULL
IVE_SUB_CD	VARCHAR2(1)	NULL
LAST_CHGD_BY	NUMBER(10,0)	NOT NULL
LAST_CHGD_DT	DATE	NOT NULL

SA_GROUP (3205)

SA_GROUP_ID (PK)	NUMBER(10,0)	NOT NULL
BUS_ORG_ID (FK)	NUMBER(10,0)	NULL
SAG_AMOUNT	NUMBER(10,0)	NULL
SAG_COMMENTS	CLOB	NULL
SAG_CONTRACT_NUM	VARCHAR2(20)	NULL
SAG_DESC	VARCHAR2(100)	NULL
SAG_START_DT	DATE	NULL
SAG_END_DT	DATE	NULL
SAG_MIN_GUAR	NUMBER(10,0)	NULL
LAST_CHGD_BY	NUMBER(10,0)	NOT NULL
LAST_CHGD_DT	DATE	NOT NULL

SA_AGREEMENT (3210)

SA_AGREEMENT_ID (PK)	NUMBER(10,0)	NOT NULL
FISCAL_CONT_LANG_ID (FK)	NUMBER(10,0)	NULL
LOCATION_ID (FK)	NUMBER(10,0)	NULL
BUS_ORG_ID (FK)	NUMBER(10,0)	NULL
PAYEE_BUS_ORG_ID (FK)	NUMBER(10,0)	NULL
PERSON_ID (FK)	NUMBER(10,0)	NULL
SAA_DESC	VARCHAR2(100)	NULL
SAA_COMMENTS	VARCHAR2(255)	NULL
SAA_ATTN_LINE	VARCHAR2(100)	NULL
LAST_CHGD_BY	NUMBER(10,0)	NOT NULL
LAST_CHGD_DT	DATE	NOT NULL

SA_AMENDMENT (3225)

SA_AMENDMENT_ID (PK)	NUMBER(10,0)	NOT NULL
SVC_ARRANGEMENT_ID (FK)	NUMBER(10,0)	NOT NULL
SVC_APR_STAFF_ID (FK)	NUMBER(10,0)	NULL
FIS_APR_STAFF_ID (FK)	NUMBER(10,0)	NULL
PAY_OTHER_VEND_IND	VARCHAR2(1)	NULL
SAM_AMOUNT	NUMBER(12,2)	NULL
SA_STATUS_CD	VARCHAR2(2)	NULL
SAM_UNITS	NUMBER(12,2)	NULL
SAM_FIS_APR_DT	DATE	NULL
SAM_SVC_APR_DT	DATE	NULL
SAM_ENTRY_DT	DATE	NULL
LAST_CHGD_BY	NUMBER(10,0)	NOT NULL
LAST_CHGD_DT	DATE	NOT NULL

SA_COMMENTS_XREF (3220)

SA_COMMENTS_XREF_ID (PK)	NUMBER(10,0)	NOT NULL
SVC_ARRANGEMENT_ID (FK)	NUMBER(10,0)	NOT NULL
COMMENTS_LOG_ID (FK)	NUMBER(10,0)	NOT NULL
LAST_CHGD_BY	NUMBER(10,0)	NOT NULL
LAST_CHGD_DT	DATE	NOT NULL

COMMENTS_LOG (3250)

COMMENTS_LOG_ID (PK)	NUMBER(10,0)	NOT NULL
STAFF_ID (FK)	NUMBER(10,0)	NULL
ENTERED_DT	DATE	NULL
SAC_COMMENTS	CLOB	NOT NULL
LAST_CHGD_BY	NUMBER(10,0)	NOT NULL
LAST_CHGD_DT	DATE	NOT NULL

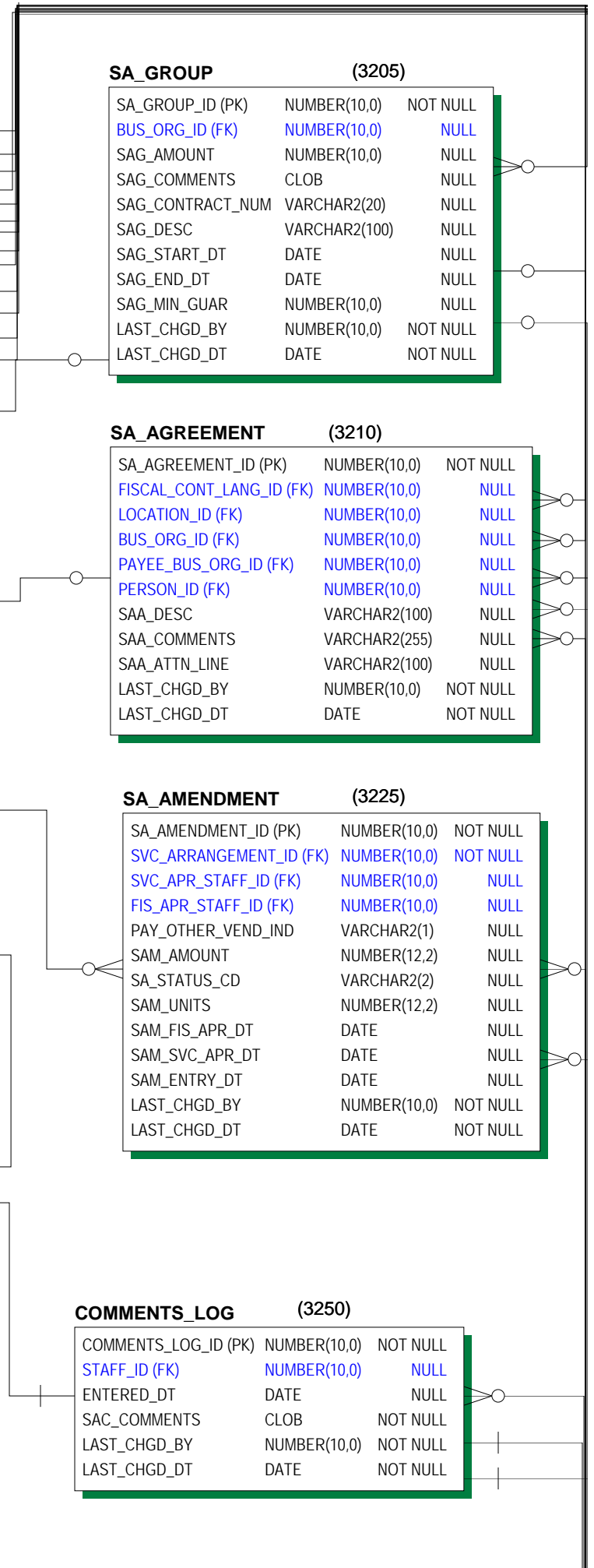

(2,2)

HCPCS_MOD_SVC (2855)

HCPCS_MOD_SVC_ID (PK)	NUMBER(10,0)	NOT NULL
HCPCS_MOD_ID (FK)	NUMBER(10,0)	NOT NULL
BRASS_SVC_ID (FK)	NUMBER(10,0)	NOT NULL
HCPCS_MOD_SVC_ST_DT	DATE	NULL
HCPCS_MOD_SVC_END_DT	DATE	NULL
LAST_CHGD_BY	NUMBER(10,0)	NOT NULL
LAST_CHGD_DT	DATE	NOT NULL

HCPCS (1470)

HCPCS_CD (PK)	VARCHAR2(5)	NOT NULL
HCPCS_DESC	VARCHAR2(65)	NULL
STAFF_LIST_IND	CHAR(1)	NULL
VENDOR_LIST_IND	CHAR(1)	NULL
HCPCS_START_DT	DATE	NULL
HCPCS_END_DT	DATE	NULL
LAST_CHGD_BY	NUMBER(10,0)	NOT NULL
LAST_CHGD_DT	DATE	NOT NULL

CPT_MODIFIER (1472)

CPT_MODIFIER (PK)	VARCHAR2(2)	NOT NULL
CPT_MOD_DESC	VARCHAR2(65)	NULL
LAST_CHGD_BY	NUMBER(10,0)	NOT NULL
LAST_CHGD_DT	DATE	NOT NULL

BRASS_TRACT_MOD (1412)

BRASS_TRACT_MOD_ID (PK)	NUMBER(10,0)	NOT NULL
BRASS_TR_ACT_ID (FK)	NUMBER(10,0)	NOT NULL
CPT_MODIFIER (FK)	VARCHAR2(2)	NOT NULL
LAST_CHGD_BY	NUMBER(10,0)	NOT NULL
LAST_CHGD_DT	DATE	NOT NULL

BRASS_TR_ACT_HCPCS (1410)

BRASS_TR_ACT_ID (PK)	NUMBER(10,0)	NOT NULL
TR_ACTIVITY_ID (FK)	NUMBER(10,0)	NOT NULL
SUBPROG_SVC_ID (FK)	NUMBER(10,0)	NOT NULL
HCPCS_CD (FK)	VARCHAR2(5)	NULL
HCPCS_PROGRAM	VARCHAR2(4)	NULL
HCPCS_UNIT_TYPE	VARCHAR2(2)	NULL
EFF_START_DT	DATE	NULL
CONT_REQ_IND	CHAR(1)	NULL
BILLING_REQ_TEXT	VARCHAR2(240)	NULL
EFF_END_DT	DATE	NULL
LAST_CHGD_BY	NUMBER(10,0)	NOT NULL
LAST_CHGD_DT	DATE	NOT NULL

CONTACT_WITH (1020)

CONT_WITH_ID (PK)	NUMBER(10,0)	NOT NULL
TIME_RECORD_ID (FK)	NUMBER(10,0)	NOT NULL
PERSON_ID (FK)	NUMBER(10,0)	NULL
CONTACT_ROLE_CD	CHAR(2)	NULL
CONT_WITH_NAME	VARCHAR2(45)	NULL
LAST_CHGD_BY	NUMBER(10,0)	NOT NULL
LAST_CHGD_DT	DATE	NOT NULL

HCPCS_MOD (2850)

HCPCS_MOD_ID (PK)	NUMBER(10,0)	NOT NULL
HCPCS_CD	VARCHAR2(5)	NOT NULL
MOD_1	VARCHAR2(2)	NULL
MOD_2	VARCHAR2(2)	NULL
MOD_3	VARCHAR2(2)	NULL
MOD_4	VARCHAR2(2)	NULL
HCPCS_MOD_START_DT	DATE	NULL
HCPCS_MOD_END_DT	DATE	NULL
UNIT_TYPE_CD	VARCHAR2(2)	NULL
HCPCS_MOD_DESC	VARCHAR2(100)	NULL
DIAG_REQ_CD	VARCHAR2(1)	NULL
CLAIM_CAT_CD	VARCHAR2(1)	NULL
CLAIM_CAT_DETAIL_CD	VARCHAR2(1)	NULL
INCL_TIME_IND	VARCHAR2(1)	NULL
INCL_PYMT_IND	VARCHAR2(1)	NULL
HCPCS_MOD_BILLING	VARCHAR2(255)	NULL
LAST_CHGD_BY	NUMBER(10,0)	NOT NULL
LAST_CHGD_DT	DATE	NOT NULL

TIME_RECORD (1000)

TIME_RECORD_ID (PK)	NUMBER(10,0)	NOT NULL
STAFF_ID (FK)	NUMBER(10,0)	NOT NULL
WG_ID (FK)	NUMBER(10,0)	NULL
TR_ACTIVITY_ID (FK)	NUMBER(10,0)	NULL
SUBPROG_ID (FK)	NUMBER(10,0)	NULL
BRASS_SVC_ID (FK)	NUMBER(10,0)	NULL
CNTY_SUBSVC_ID (FK)	NUMBER(10,0)	NULL
DOCUMENT_ID (FK)	NUMBER(10,0)	NULL
DURATION	NUMBER(10,0)	NOT NULL
ACTIVITY_DT	DATE	NOT NULL
HCPCS_CD	VARCHAR2(5)	NULL
NUM_PERS_REC_SVC	VARCHAR2(3)	NULL
CNTY_OF_SVC_CD	CHAR(2)	NULL
TR_STAT_CD	CHAR(1)	NULL
CNTY_ACCTG_CODE	VARCHAR2(10)	NULL
CONTACT_METHOD_CD	CHAR(1)	NULL
CONTACT_LOC_CD	CHAR(1)	NULL
CONTACT_STATUS_CD	CHAR(1)	NULL
PURPOSE	VARCHAR2(60)	NULL
LAST_CHGD_BY	NUMBER(10,0)	NOT NULL
LAST_CHGD_DT	DATE	NOT NULL

TIME_RECORD_MOD (1050)

TIME_RECORD_MOD_ID (PK)	NUMBER(10,0)	NOT NULL
TIME_RECORD_ID (FK)	NUMBER(10,0)	NOT NULL
CPT_MODIFIER (FK)	VARCHAR2(2)	NOT NULL
LAST_CHGD_BY	NUMBER(10,0)	NOT NULL
LAST_CHGD_DT	DATE	NOT NULL

ON_BEHALF_OF (1005)

ON_BEHALF_OF_ID (PK)	NUMBER(10,0)	NOT NULL
PROV_ID (FK)	NUMBER(10,0)	NULL
PERSON_ID (FK)	NUMBER(10,0)	NULL
TIME_RECORD_ID (FK)	NUMBER(10,0)	NOT NULL
DURATION	NUMBER(10,0)	NULL
LEGACY_CLAIM_DT	DATE	NULL
LAST_CHGD_BY	NUMBER(10,0)	NOT NULL
LAST_CHGD_DT	DATE	NOT NULL

HPCPCS_MOD_SVC_ACT (2865)

HPCPCS_MOD_SVC_ACT_ID (PK)	NUMBER(10,0)	NOT NULL
HPCPCS_MOD_SVC_ID (FK)	NUMBER(10,0)	NOT NULL
TR_ACTIVITY_ID (FK)	NUMBER(10,0)	NOT NULL
HMSA_START_DT	DATE	NULL
HMSA_END_DT	DATE	NULL
LAST_CHGD_BY	NUMBER(10,0)	NOT NULL
LAST_CHGD_DT	DATE	NOT NULL

CNTY_HPCPCS_MOD_RATE (2860)

CNTY_HPCPCS_RATE_ID (PK)	NUMBER(10,0)	NOT NULL
HPCPCS_MOD_ID (FK)	NUMBER(10,0)	NOT NULL
CHM_RATE	NUMBER(14,4)	NULL
CLAIM_CAT_DETAIL_CD	VARCHAR2(1)	NULL
CHM_RATE_START_DT	DATE	NULL
CHM_RATE_END_DT	DATE	NULL
LAST_CHGD_BY	NUMBER(10,0)	NOT NULL
LAST_CHGD_DT	DATE	NOT NULL

TRACT_SVC_METH_MOD (1457)

TR_SVCMETH_MOD_ID (PK)	NUMBER(10,0)	NOT NULL
TR_ACT_SVC_METH_ID (FK)	NUMBER(10,0)	NOT NULL
CPT_MODIFIER (FK)	VARCHAR2(2)	NOT NULL
EFF_START_DT	DATE	NULL
EFF_END_DT	DATE	NULL
LAST_CHGD_BY	NUMBER(10,0)	NOT NULL
LAST_CHGD_DT	DATE	NOT NULL

TR_ACT_SVC_METHOD (1455)

TR_ACT_SVC_METH_ID (PK)	NUMBER(10,0)	NOT NULL
TR_ACTIVITY_ID (FK)	NUMBER(10,0)	NOT NULL
SUBPROG_SVC_ID (FK)	NUMBER(10,0)	NOT NULL
CONTACT_METHOD_CD	CHAR(1)	NOT NULL
HPCPCS_CD	VARCHAR2(5)	NULL
EFF_START_DT	DATE	NULL
EFF_END_DT	DATE	NULL
LAST_CHGD_BY	NUMBER(10,0)	NOT NULL
LAST_CHGD_DT	DATE	NOT NULL

TR_ACTIVITY (1405)

TR_ACTIVITY_ID (PK)	NUMBER(10,0)	NOT NULL
DESCRIPTION	VARCHAR2(65)	NOT NULL
ACT_TYPE_CD	CHAR(1)	NULL
CONT_REQ_IND	CHAR(1)	NULL
EFF_START_DT	DATE	NULL
EFF_END_DT	DATE	NULL
CNTY_VIS_IND	VARCHAR2(1)	NULL
LAST_CHGD_BY	NUMBER(10,0)	NOT NULL
LAST_CHGD_DT	DATE	NOT NULL

RETENTION_PERIOD (1468)

RPERIOD_ID (PK)	NUMBER(10,0)	NOT NULL
RPERIOD_NAME	VARCHAR2(80)	NULL
RETENTION_CRIT_CD	CHAR(1)	NULL
SUBPROG_ID (FK)	NUMBER(10,0)	NULL
RPERIOD	NUMBER(10,0)	NULL
RPERIOD_MIN	NUMBER(10,0)	NULL
TRACK_CD	VARCHAR2(1)	NULL
LAST_CHGD_BY	NUMBER(10,0)	NOT NULL
LAST_CHGD_DT	DATE	NOT NULL

BUS_ORG_EMAIL_XREF (2375)

BUS_ORG_EMAIL_ID (PK)	NUMBER(10,0)	NOT NULL
EMAIL_ID (FK)	NUMBER(10,0)	NOT NULL
BUS_ORG_ID (FK)	NUMBER(10,0)	NOT NULL
EMAIL_TYPE_CD	VARCHAR2(1)	NULL
LAST_CHGD_BY	NUMBER(10,0)	NOT NULL
LAST_CHGD_DT	DATE	NOT NULL

EMAIL (2370)

EMAIL_ID (PK)	NUMBER(10,0)	NOT NULL
EMAIL_ADDRESS	VARCHAR2(100)	NULL
EMAIL_COMMENT	VARCHAR2(100)	NULL
LAST_CHGD_BY	NUMBER(10,0)	NOT NULL
LAST_CHGD_DT	DATE	NOT NULL

PERSON_EMAIL_XREF (597)

PERSON_EMAIL_ID (PK)	NUMBER(10,0)	NOT NULL
PERSON_ID (FK)	NUMBER(10,0)	NOT NULL
EMAIL_ID (FK)	NUMBER(10,0)	NOT NULL
EMAIL_TYPE_CD	VARCHAR2(1)	NOT NULL
LAST_CHGD_BY	NUMBER(10,0)	NOT NULL
LAST_CHGD_DT	DATE	NOT NULL

LIC_RPT_XREF (1710)

PROV_LIC_DETAIL_ID (PK)(FK)	NUMBER(10,0)	NOT NULL
REPORT_ID (PK)(FK)	NUMBER(10,0)	NOT NULL
LAST_CHGD_BY	NUMBER(10,0)	NOT NULL
LAST_CHGD_DT	DATE	NOT NULL

REPORT (1700)

REPORT_ID (PK)	NUMBER(10,0)	NOT NULL
WG_ID (FK)	NUMBER(10,0)	NULL
REPORT_DESC	VARCHAR2(65)	NOT NULL
CREATED_DT	DATE	NOT NULL
REPORT_TYPE_CD	CHAR(1)	NOT NULL
REPORT_BLOB	BLOB	NULL
LAST_CHGD_BY	NUMBER(10,0)	NOT NULL
LAST_CHGD_DT	DATE	NOT NULL

BATCH_OWNER (3930)

BATCH_OWNER_ID (PK)	NUMBER(10,0)	NOT NULL
ACCT_SYS_USER	VARCHAR2(10)	NULL
BATCH_USER_NAME	VARCHAR2(65)	NULL
LAST_CHGD_BY	NUMBER(10,0)	NOT NULL
LAST_CHGD_DT	DATE	NOT NULL

PROV_LIC_DETAIL (820)

PROV_LIC_DETAIL_ID (PK)	NUMBER(10,0)	NOT NULL
WG_ID (FK)	NUMBER(10,0)	NULL
BUS_ORG_ID (FK)	NUMBER(10,0)	NULL
FACILITY_ADDR_ID (FK)	NUMBER(10,0)	NULL
PROV_LIC_ADDR_ID (FK)	NUMBER(10,0)	NULL
PROV_LIC_NUM	VARCHAR2(10)	NULL
PROV_LIC_START_DT	DATE	NULL
PROV_LIC_END_DT	DATE	NULL
FACILITY_TYPE_CD	VARCHAR2(3)	NULL
IMD_IND	CHAR(1)	NULL
LICENSE_TYPE_CD	CHAR(2)	NOT NULL
LICENSE_STAT_CD	CHAR(1)	NOT NULL
LICENSED_CAPACITY	NUMBER(10,0)	NULL
LICENSED_BY_CD	CHAR(2)	NOT NULL
ISSUED_BY_CD	CHAR(1)	NOT NULL
TRIBE_CD	CHAR(3)	NULL
LICENSE_STAT_DT	DATE	NULL
MIN_AGE_WILL_SRV	NUMBER(3,0)	NULL
MAX_AGE_WILL_SRV	NUMBER(3,0)	NULL
GENDER_WILL_SRV_CD	CHAR(1)	NULL
LIC_CNTY_CD	CHAR(2)	NULL
CORP_LIC_IND	CHAR(1)	NULL
DHS_PROV_NUM	VARCHAR2(10)	NULL
CORP_NUM	VARCHAR2(10)	NULL
FAC_NUM	VARCHAR2(10)	NULL
FACILITY_NAME	VARCHAR2(40)	NULL
NON_RES_OCCUP_IND	CHAR(1)	NULL
RES_TYPE_CD	CHAR(1)	NULL
WELL_WATER_IND	CHAR(1)	NULL
RENT_IND	CHAR(1)	NULL
LIC_ACTION_TYPE_CD	CHAR(1)	NULL
LIC_CLOSE_REAS_CD	CHAR(1)	NULL
BACK_STUDY_DT	DATE	NULL
FIRE_INSPECT_DT	DATE	NULL
APP_CLOSE_DT	DATE	NULL
DUAL_LIC_TYPE_CD	CHAR(1)	NULL
DUAL_LIC_IND	CHAR(1)	NULL
PROV_LIC_NUM_VERS	VARCHAR2(2)	NULL
PILOT_PROJ_IND	CHAR(1)	NULL
HOUSING_SVCS_IND	CHAR(1)	NULL
FACILITY_PHONE	VARCHAR2(50)	NULL
LICENSOR_NUM	VARCHAR2(5)	NULL
LAST_CHGD_BY	NUMBER(10,0)	NOT NULL
LAST_CHGD_DT	DATE	NOT NULL

LICENSE_CLASS (822)

LICENSE_CLASS_ID (PK)	NUMBER(10,0)	NOT NULL
PROV_LIC_DETAIL_ID (FK)	NUMBER(10,0)	NOT NULL
LICENSE_CLASS_CD	CHAR(2)	NULL
LAST_CHGD_BY	NUMBER(10,0)	NOT NULL
LAST_CHGD_DT	DATE	NOT NULL

IND_PROVIDER (870)

IND_PROV_ID (PK)	NUMBER(10,0)	NOT NULL
PROV_ID (FK)	NUMBER(10,0)	NOT NULL
PERSON_ID (FK)	NUMBER(10,0)	NOT NULL
LAST_CHGD_BY	NUMBER(10,0)	NOT NULL
LAST_CHGD_DT	DATE	NOT NULL

PROVIDER (800)

PROV_ID (PK)	NUMBER(10,0)	NOT NULL
BUS_ORG_ID (FK)	NUMBER(10,0)	NOT NULL
STRUCT_FOST_FAM_CD	CHAR(1)	NULL
REGISTERED_CC_IND	VARCHAR2(1)	NULL
SCHOOL_DIST_NUM	CHAR(4)	NULL
CHILD_FC_CD	CHAR(1)	NULL
IV_E_ELIG_PROV_IND	CHAR(1)	NULL
LAST_CHGD_BY	NUMBER(10,0)	NOT NULL
LAST_CHGD_DT	DATE	NOT NULL

LICENSE_ACTIONS (885)

LIC_ACTION_ID (PK)	NUMBER(10,0)	NOT NULL
PROV_LIC_DETAIL_ID (FK)	NUMBER(10,0)	NULL
LIC_ACTION_DT	DATE	NULL
LIC_ACTION_CD	CHAR(1)	NULL
LIC_ACT_COMMENT	VARCHAR2(200)	NULL
LAST_CHGD_BY	NUMBER(10,0)	NOT NULL
LAST_CHGD_DT	DATE	NOT NULL

CONDITIONAL_AREAS (895)

COND_AREAS_ID (PK)	NUMBER(10,0)	NOT NULL
PROV_LIC_DETAIL_ID (FK)	NUMBER(10,0)	NULL
AREAS_CD	CHAR(1)	NULL
LAST_CHGD_BY	NUMBER(10,0)	NOT NULL
LAST_CHGD_DT	DATE	NOT NULL

DWELLING_AREAS (890)

DWELLING_AREAS_ID (PK)	NUMBER(10,0)	NOT NULL
PROV_LIC_DETAIL_ID (FK)	NUMBER(10,0)	NULL
AREAS_CD	CHAR(1)	NULL
LAST_CHGD_BY	NUMBER(10,0)	NOT NULL
LAST_CHGD_DT	DATE	NOT NULL

PROV_PLACEMENT (888)

PROV_PLACEMT_ID (PK)	NUMBER(10,0)	NOT NULL
PROV_LIC_DETAIL_ID (FK)	NUMBER(10,0)	NULL
CLIENT_NAME	VARCHAR2(50)	NULL
BIRTH_DT	DATE	NULL
GENDER_CD	CHAR(1)	NULL
PLACE_AGCY_NAME	VARCHAR2(50)	NULL
PLACE_WORKER_NAME	VARCHAR2(50)	NULL
PLACE_START_DT	DATE	NULL
PLACE_END_DT	DATE	NULL
REASON_LEAVING	VARCHAR2(65)	NULL
LAST_CHGD_BY	NUMBER(10,0)	NOT NULL
LAST_CHGD_DT	DATE	NOT NULL

PREF_CLIENTS (823)

PREF_CLIENTS_ID (PK)	NUMBER(10,0)	NOT NULL
PROV_LIC_DETAIL_ID (FK)	NUMBER(10,0)	NOT NULL
PREF_CLIENTS_CD	CHAR(1)	NULL
LAST_CHGD_BY	NUMBER(10,0)	NOT NULL
LAST_CHGD_DT	DATE	NOT NULL

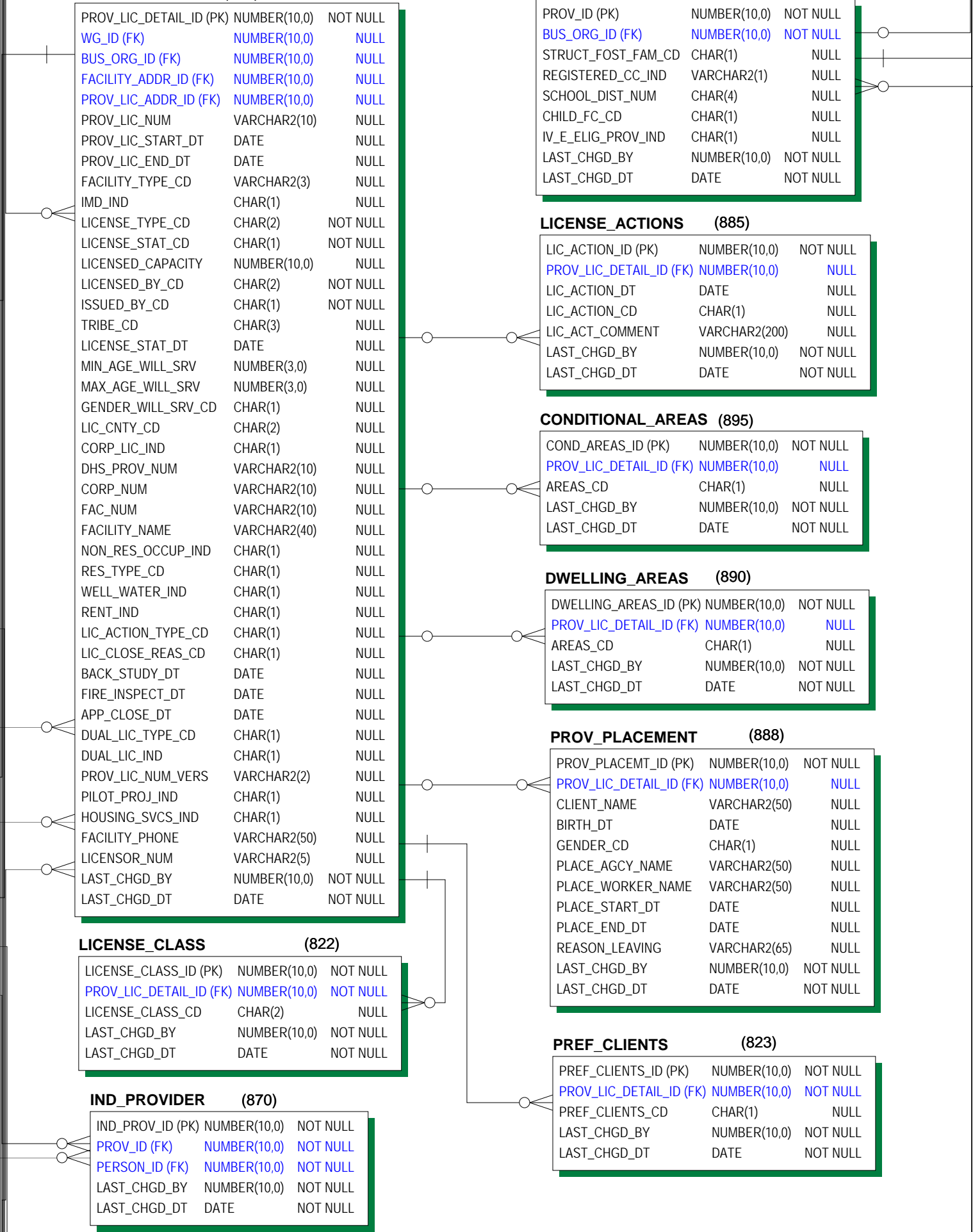

(2,5)

DI_CHLD_ELIG_SBM (2510)

DI_CHLD_ELIG_SBM_ID (PK)	NUMBER(10,0)	NOT NULL
DATA_TYPE	VARCHAR2(4)	NULL
PERSON_ID (FK)	NUMBER(10,0)	NOT NULL
CONTPLCMT_ID (FK)	NUMBER(10,0)	NOT NULL
STAFF_ID (FK)	NUMBER(10,0)	NULL
CONTPLCMT_START_DT	DATE	NULL
CONTPLCMT_END_DT	DATE	NULL
PETITION_DT	DATE	NULL
BEST_INTEREST_DT	DATE	NULL
REAS_EFF_PERM_DT	DATE	NULL
REASONABLE_EFF_DT	DATE	NULL
REASONABLE_EFF_CD	CHAR(1)	NULL
VOL_PLCMT_AGRMT_DT	DATE	NULL
COURT_HEARING_DT	DATE	NULL
PMI	VARCHAR2(10)	NULL
ELIG_SUBMIT_CD	VARCHAR2(2)	NULL
SUBMIT_DT	DATE	NULL
SMI_ID	NUMBER(10,0)	NULL
CHIPS_IND	VARCHAR2(1)	NULL
CHIPS_DT	DATE	NULL
SUP_AGCY_CD	VARCHAR2(1)	NULL
IVE_MNT_AGR_EFF_DT	DATE	NULL
IVE_MNT_AGR_END_DT	DATE	NULL
UMBRELLA_CO_IND	VARCHAR2(1)	NULL
ENTERED_FC_DT	DATE	NULL
SUP_TRIBE_CD	VARCHAR2(3)	NULL
FC_EXTENSION_IND	VARCHAR2(1)	NULL
FC_EXTENSION_DT	DATE	NULL
LAST_CHGD_BY	NUMBER(10,0)	NOT NULL
LAST_CHGD_DT	DATE	NOT NULL

ELIG_DD_SCRNG (3417)

ELIG_DD_SCRNG_ID (PK)	NUMBER(10,0)	NOT NULL
PERSON_ID (FK)	NUMBER(10,0)	NULL
WG_ID (FK)	NUMBER(10,0)	NULL
READY_TO_CLAIM_IND	VARCHAR2(1)	NULL
DD_SCREENING_DT	DATE	NULL
LAST_CHGD_BY	NUMBER(10,0)	NOT NULL
LAST_CHGD_DT	DATE	NOT NULL

TICKLER_TYPE (1235)

TICKLER_TYPE_ID (PK)	NUMBER(10,0)	NOT NULL
TICKLER_NAME	VARCHAR2(60)	NULL
TICKLER_PERIOD	NUMBER(10,0)	NULL
TICKLER_LEADTIME	NUMBER(10,0)	NULL
TICKLER_SQL1	VARCHAR2(4000)	NULL
TICKLER_SQL2	VARCHAR2(4000)	NULL
TICKLER_SQL3	VARCHAR2(4000)	NULL
NEXT_GEN_DT	DATE	NULL
ALERT_CD	CHAR(1)	NULL
ENABLED_IND	VARCHAR2(1)	NULL
LAST_CHGD_BY	NUMBER(10,0)	NOT NULL
LAST_CHGD_DT	DATE	NOT NULL

TICKLER (1230)

TICKLER_ID (PK)	NUMBER(10,0)	NOT NULL
TICKLER_TYPE_ID (FK)	NUMBER(10,0)	NOT NULL
STAFF_ID (FK)	NUMBER(10,0)	NOT NULL
PERSON_ID (FK)	NUMBER(10,0)	NULL
WG_ID (FK)	NUMBER(10,0)	NULL
TICKLER_DT	DATE	NULL
TICKLER_DUE_DT	DATE	NULL
TICKLER_DESC	VARCHAR2(240)	NULL
ALERT_CD	CHAR(1)	NULL
LAST_CHGD_BY	NUMBER(10,0)	NOT NULL
LAST_CHGD_DT	DATE	NOT NULL

TICKLER_ERROR (1240)

TICKLER_ERROR_ID (PK)	NUMBER(10,0)	NOT NULL
TICKLER_TYPE_ID (FK)	NUMBER(10,0)	NULL
TICKLER_ERROR_MSG	VARCHAR2(1000)	NULL
TICKLER_NAME	VARCHAR2(60)	NULL
LAST_CHGD_BY	NUMBER(10,0)	NOT NULL
LAST_CHGD_DT	DATE	NOT NULL

CHECKLIST_ITEM (1215)

CHECKLIST_ITEM_ID (PK)	NUMBER(10,0)	NOT NULL
ITEM_DESC	VARCHAR2(130)	NULL
ITEM_DEFINITION	VARCHAR2(600)	NULL
LAST_CHGD_BY	NUMBER(10,0)	NULL
LAST_CHGD_DT	DATE	NULL

CHECKLIST_DETAIL (1210)

CHECKLIST_DET_ID (PK)	NUMBER(10,0)	NOT NULL
CHECKLIST_ID (FK)	NUMBER(10,0)	NULL
CHECKLIST_ITEM_ID (FK)	NUMBER(10,0)	NULL
PARENT_ITEM_ID (FK)	NUMBER(10,0)	NULL
CHECKED_IND	CHAR(1)	NULL
CLIST_DET_STAT_CD	CHAR(1)	NULL
CLIST_DET_STAT_DT	DATE	NULL
CLIST_DET_COMMENTS	VARCHAR2(160)	NULL
LAST_CHGD_BY	NUMBER(10,0)	NULL
LAST_CHGD_DT	DATE	NULL

CLIST_TEMPL_DETAIL (1225)

CLIST_TEMPL_DET_ID (PK)	NUMBER(10,0)	NOT NULL
CHECKLIST_TEMPL_ID (FK)	NUMBER(10,0)	NULL
CHECKLIST_ITEM_ID (FK)	NUMBER(10,0)	NULL
PARENT_ITEM_ID (FK)	NUMBER(10,0)	NULL
CLIST_SEQ_NUM	NUMBER(10,0)	NULL
LAST_CHGD_BY	NUMBER(10,0)	NULL
LAST_CHGD_DT	DATE	NULL

CHECKLIST_TEMPL (1220)

CHECKLIST_TEMPL_ID (PK)	NUMBER(10,0)	NOT NULL
TEMPLATE_NAME	VARCHAR2(50)	NULL
SUBPROG_ID (FK)	NUMBER(10,0)	NULL
WG_TYPE_CD	CHAR(1)	NULL
CLIST_TYPE_CD	CHAR(1)	NULL
TRACK_CD	VARCHAR2(1)	NULL
LAST_CHGD_BY	NUMBER(10,0)	NULL
LAST_CHGD_DT	DATE	NULL

CHECKLIST (1205)

CHECKLIST_ID (PK)	NUMBER(10,0)	NOT NULL
CHECKLIST_TEMPL_ID (FK)	NUMBER(10,0)	NULL
WG_ID (FK)	NUMBER(10,0)	NULL
PLCMT_LOC_ID (FK)	NUMBER(10,0)	NULL
CLIST_CREATED_DT	DATE	NULL
CLIST_FINALIZE_DT	DATE	NULL
LAST_CHGD_BY	NUMBER(10,0)	NULL
LAST_CHGD_DT	DATE	NULL

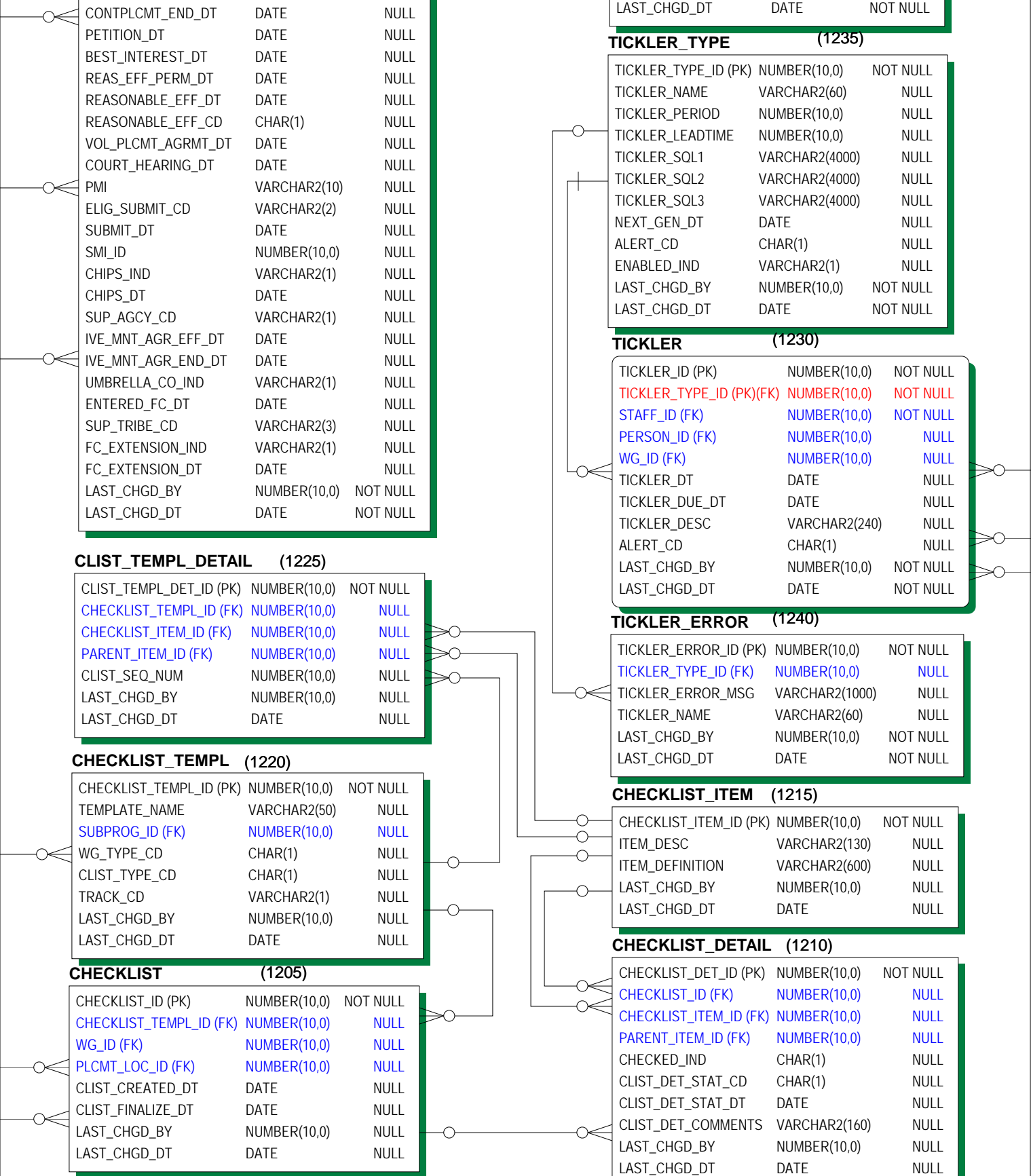

(2,6)

CLM_DD_SCRNG_XREF (3418)

CLM_DD_SCRNG_XREF_ID (PK)	NUMBER(10,0)	NOT NULL
CLM_HEALTHCARE_ID (FK)	NUMBER(10,0)	NOT NULL
ELIG_DD_SCRNG_ID (FK)	NUMBER(10,0)	NOT NULL
LAST_CHGD_BY	NUMBER(10,0)	NOT NULL
LAST_CHGD_DT	DATE	NOT NULL

DI_ELIG_LTC_DIAG (3430)

DI_ELIG_LTC_DIAG_ID (PK)	NUMBER(10,0)	NOT NULL
DI_ELIG_LTC_SCRNG_ID (FK)	NUMBER(10,0)	NOT NULL
DIAGNOSIS_CD	VARCHAR2(6)	NOT NULL
DIAG_INDEX	NUMBER(10,0)	NULL
LAST_CHGD_BY	NUMBER(10,0)	NOT NULL
LAST_CHGD_DT	DATE	NOT NULL

ELIG_DO_NOT_CLAIM (3495)

ELIG_DO_NOT_CLAIM_ID (PK)	NUMBER(10,0)	NOT NULL
PERSON_ID (FK)	NUMBER(10,0)	NULL
WG_ID (FK)	NUMBER(10,0)	NULL
CLAIM_CAT_CD	VARCHAR2(1)	NULL
ELIG_START_DT	DATE	NULL
ELIG_END_DT	DATE	NULL
DNC_COMMENTS	VARCHAR2(255)	NULL
ELIG_DNC_REASON_CD	VARCHAR2(1)	NULL
LAST_CHGD_BY	NUMBER(10,0)	NOT NULL
LAST_CHGD_DT	DATE	NOT NULL

IVE_UMB_CNTY (3600)

IVE_UMB_CNTY_ID (PK)	NUMBER(10,0)	NOT NULL
CORR_UMB_CNTY_EFF_DT	DATE	NULL
CORR_UMB_CNTY_END_DT	DATE	NULL
LAST_CHGD_BY	NUMBER(10,0)	NOT NULL
LAST_CHGD_DT	DATE	NOT NULL

PYMT_CONF_IMPORT (3910)

PYMT_CONF_IMPORT_ID (PK)	NUMBER(10,0)	NOT NULL
PAYMENT_ID (FK)	NUMBER(10,0)	NOT NULL
IMPORTED_DT	DATE	NULL
PCONF_IMP_STATUS_CD	VARCHAR2(1)	NULL
PYMT_PAID_AMT	NUMBER(12,2)	NOT NULL
PYMT_WARRANT_DT	DATE	NOT NULL
PYMT_WARRANT_NUM	VARCHAR2(20)	NOT NULL
PYMT_WARRANT_TOT_AMT	NUMBER(12,2)	NOT NULL
LAST_CHGD_BY	NUMBER(10,0)	NOT NULL
LAST_CHGD_DT	DATE	NOT NULL

PYMT_HDR_EXPORT (3920)

PYMT_HDR_EXPORT_ID (PK)	NUMBER(10,0)	NOT NULL
PYMT_BATCH_ID (FK)	NUMBER(10,0)	NOT NULL
STAFF_ID (FK)	NUMBER(10,0)	NOT NULL
ACCT_SYS_USER	VARCHAR2(10)	NULL
SUBMITTED_DT	DATE	NULL
PYMT_BATCH_AMT	NUMBER(12,2)	NOT NULL
PYMT_BATCH_CNT	NUMBER(10,0)	NOT NULL
PYMT_BATCH_DESC	VARCHAR2(100)	NULL
PBATCH_SCH_WARR_DT	DATE	NULL
LAST_CHGD_BY	NUMBER(10,0)	NOT NULL
LAST_CHGD_DT	DATE	NOT NULL

MMIS_CODE (3490)

FIELDNAME (PK)	VARCHAR2(20)	NOT NULL
CODE (PK)	VARCHAR2(6)	NOT NULL
DESCRIPTION	VARCHAR2(65)	NOT NULL
SORT_ORDER	NUMBER(10,0)	NULL
ACTIVE_IND	CHAR(1)	NULL
MMIS_CODE_COMMENTS	CLOB	NULL
LAST_CHGD_BY	NUMBER(10,0)	NOT NULL
LAST_CHGD_DT	DATE	NOT NULL

IVE_MNT_AGR (3610)

IVE_MNT_AGR_ID (PK)	NUMBER(10,0)	NOT NULL
MNT_AGR_EFF_DT	DATE	NULL
MNT_AGR_END_DT	DATE	NULL
MNT_AGR_WITH_CD	VARCHAR2(1)	NULL
MNT_AGR_ST_LVL_IND	VARCHAR2(1)	NULL
SUP_TRIBE_CD	VARCHAR2(3)	NULL
LAST_CHGD_BY	NUMBER(10,0)	NOT NULL
LAST_CHGD_DT	DATE	NOT NULL

SGR_REVENUES_EXP (4270)

SGR_REVENUES_EXP_ID (PK)	NUMBER(10,0)	NOT NULL
CNTY_CD (PK)(FK)	CHAR(2)	NOT NULL
SGR_RPT_EXP_ID (FK)	NUMBER(10,0)	NOT NULL
DHS_ENTRY_NUM	VARCHAR2(4)	NULL
REV_AMOUNT	NUMBER(12,2)	NULL
REV_DESC	VARCHAR2(65)	NULL
REV_ORDER	NUMBER(10,0)	NULL
REV_TYPE_CD	VARCHAR2(1)	NULL
LAST_CHGD_BY	NUMBER(10,0)	NOT NULL
LAST_CHGD_DT	DATE	NOT NULL

SGR_RPT_EXP (4260)

SGR_RPT_EXP_ID (PK)	NUMBER(10,0)	NOT NULL
CNTY_CD (PK)	CHAR(2)	NOT NULL
ST_RPT_PERIOD_CD	VARCHAR2(2)	NULL
SS_EXPENSE	NUMBER(12,0)	NULL
SS_STAFF_COST	NUMBER(12,2)	NULL
ST_RPT_YEAR	VARCHAR2(4)	NULL
ST_RPT_GEN_DT	DATE	NULL
ST_RPT_REV_NUM	NUMBER(3,0)	NULL
ST_RPT_CONTACT_NAME	VARCHAR2(65)	NULL
ST_CONTACT_PHONE	VARCHAR2(50)	NULL
LAST_CHGD_BY	NUMBER(10,0)	NOT NULL
LAST_CHGD_DT	DATE	NOT NULL

SGR_SERVICE_EXP (4265)

SGR_SERVICE_EXP_ID (PK)	NUMBER(10,0)	NOT NULL
CNTY_CD (PK)(FK)	CHAR(2)	NOT NULL
SGR_RPT_EXP_ID (FK)	NUMBER(10,0)	NOT NULL
BRASS_SVC_ID (FK)	NUMBER(10,0)	NULL
HOURS_SVC	NUMBER(12,2)	NULL
PURCHASED_SVC	NUMBER(12,0)	NULL
STAFF_COST	NUMBER(12,2)	NULL
TOTAL_COST	NUMBER(12,2)	NULL
UNITS_PURCHASED_SVC	NUMBER(10,3)	NULL
LAST_CHGD_BY	NUMBER(10,0)	NOT NULL
LAST_CHGD_DT	DATE	NOT NULL

CNTY_WG_RESULTS

CNTY_CD	CHAR(2)	NULL
WG_LABEL	VARCHAR2(80)	NULL
TRACK_CD	VARCHAR2(1)	NULL
WG_ID	NUMBER(10,0)	NULL
SUBPROG_ID	NUMBER(10,0)	NULL
WG_START_DT	DATE	NULL
WG_END_DT	DATE	NULL
LAST_NAME2	VARCHAR2(30)	NULL
FIRST_NAME2	VARCHAR2(20)	NULL
MIDDLE_NAME2	VARCHAR2(20)	NULL
NAME_SUFFIX2	VARCHAR2(5)	NULL
PHONE	VARCHAR2(50)	NULL
CNTY_CASE_NUM	VARCHAR2(10)	NULL
LAST_NAME	VARCHAR2(30)	NULL
FIRST_NAME	VARCHAR2(20)	NULL
MIDDLE_NAME	VARCHAR2(20)	NULL
NAME_SUFFIX	VARCHAR2(5)	NULL
SW_INDEX_ID	NUMBER(10,0)	NULL
CLEARING_STATUS_CD	CHAR(1)	NULL
BIRTH_DT	DATE	NULL
AGE	NUMBER(5,0)	NULL
DECEASED_DT	DATE	NULL
SSN	VARCHAR2(9)	NULL
GENDER_CD	CHAR(1)	NULL
PERSON_ID	NUMBER(10,0)	NULL
CNTY_PERSON_NUM	VARCHAR2(10)	NULL
ESTIMATED_BIRTH_DT	DATE	NULL
REQUEST_DT	DATE	NULL
RESPONSE_DT	DATE	NULL
ACCESS_APPROVED_IND	VARCHAR2(1)	NULL
FOLDER_ID	NUMBER(10,0)	NULL
STAFF_ID	NUMBER(10,0)	NULL

CNTY_TPR_RESULTS

CNTY_CD	CHAR(2)	NULL
RELATION_ID	NUMBER(10,0)	NULL
LAST_NAME	VARCHAR2(30)	NULL
FIRST_NAME	VARCHAR2(20)	NULL
MIDDLE_NAME	VARCHAR2(20)	NULL
TERM_DT	DATE	NULL
TERM_REASON_CD	VARCHAR2(1)	NULL
TPR_TYPE_CD	VARCHAR2(1)	NULL

CLM_PYMT_RECS

PAYMENT_ID	NUMBER(10,0)	NOT NULL
BRASS_SVC_ID	NUMBER(10,0)	NULL
PERSON_ID	NUMBER(10,0)	NULL
HCPCS_MOD_ID	NUMBER(10,0)	NULL
CONTACT_LOC_CD	CHAR(1)	NULL
PYMT_PAID_AMT	NUMBER(12,2)	NULL
PYMT_UNITS	NUMBER(12,2)	NULL
PYMT_SVC_START_DT	DATE	NULL
PYMT_SVC_END_DT	DATE	NULL
PMI	VARCHAR2(10)	NULL
CNTY_CD	CHAR(2)	NULL
SCRNG_ID	NUMBER(10,0)	NULL
SCRNG_DT	DATE	NULL
WAIVER_TYPE	VARCHAR2(2)	NULL

CNTY_CPRPT_RESULTS

CNTY_CD	CHAR(2)	NULL
WG_LABEL	VARCHAR2(80)	NULL
TRACK_CD	VARCHAR2(1)	NULL
WG_ID	NUMBER(10,0)	NULL
WG_START_DT	DATE	NULL
CP_RPT_STATUS_CD	VARCHAR2(2)	NULL
CP_RPT_END_DT	DATE	NULL
MALT_DETERM_IND	VARCHAR2(1)	NULL
CP_SVCS_NEED_IND	VARCHAR2(1)	NULL
CP_RPT_END_REASON_CD	VARCHAR2(2)	NULL
FACILITY_RESP_IND	VARCHAR2(1)	NULL
INDV_RESP_IND	VARCHAR2(1)	NULL
APPEAL_DETERM_IND	VARCHAR2(1)	NULL
CP_RPT_ID	NUMBER(10,0)	NULL
REC_LIC_ACTION_IND	VARCHAR2(1)	NULL
ALLEGATION_CD	VARCHAR2(1)	NULL
VICTIM_ID	NUMBER(10,0)	NULL
V_LAST_NAME	VARCHAR2(65)	NULL
V_MIDDLE_NAME	VARCHAR2(20)	NULL
V_FIRST_NAME	VARCHAR2(20)	NULL
V_NAME_SUFFIX	VARCHAR2(5)	NULL
OFFENDER_ID	NUMBER(10,0)	NULL
O_LAST_NAME	VARCHAR2(65)	NULL
O_MIDDLE_NAME	VARCHAR2(20)	NULL
O_FIRST_NAME	VARCHAR2(20)	NULL
O_NAME_SUFFIX	VARCHAR2(5)	NULL
ALLEG_DETERM_IND	VARCHAR2(1)	NULL
PERSON1_NEU_DESC	VARCHAR2(50)	NULL
DETERMINED_IND	CHAR(1)	NULL
V_SW_INDEX_ID	NUMBER(10,0)	NULL
O_SW_INDEX_ID	NUMBER(10,0)	NULL

CNTY_MALT_DATA_SWNDX

OFFENDER_SW_INDEX_ID	NUMBER(10,0)	NULL
CMDS_MESSAGE	VARCHAR2(80)	NULL
CNTY_CD	CHAR(2)	NULL
ALLEG_DETERM_DT	DATE	NULL
CP_ALLEG_DETAIL_ID	NUMBER(10,0)	NULL
CP_ALLEG_DETAIL_CD	VARCHAR2(2)	NULL

CLM_TIME_RECS

TIME_RECORD_ID	NUMBER(10,0)	NOT NULL
STAFF_ID	NUMBER(10,0)	NULL
ON_BEHALF_OF_ID	NUMBER(10,0)	NULL
TR_ACTIVITY_ID	NUMBER(10,0)	NULL
BRASS_SVC_ID	NUMBER(10,0)	NULL
DURATION	NUMBER(10,0)	NULL
ACTIVITY_DT	DATE	NULL
CNTY_OF_SVC_CD	CHAR(2)	NULL
COUNTY_DESC	VARCHAR2(65)	NULL
TR_STAT_CD	CHAR(1)	NULL
CONTACT_METHOD_CD	CHAR(1)	NULL
CONTACT_LOC_CD	CHAR(1)	NULL
CONTACT_STATUS_CD	CHAR(1)	NULL
PERSON_ID	NUMBER(10,0)	NULL
PMI	VARCHAR2(10)	NULL
HCPCS_MOD_ID	NUMBER(10,0)	NULL
SCRNG_ID	NUMBER(10,0)	NULL
SCRNG_DT	DATE	NULL
WAIVER_TYPE	VARCHAR2(2)	NULL

PAYMENT

(3300)

PAYMENT_ID (PK)	NUMBER(10,0)	NOT NULL
ORIG_PAYMENT_ID (FK)	NUMBER(10,0)	NULL
SA_GROUP_ID (FK)	NUMBER(10,0)	NULL
SVC_ARRANGEMENT_ID (FK)	NUMBER(10,0)	NULL
APPROVAL_STAFF_ID (FK)	NUMBER(10,0)	NULL
SUBPROG_ID (FK)	NUMBER(10,0)	NULL
BRASS_SVC_ID (FK)	NUMBER(10,0)	NULL
CNTY_SUBSVC_ID (FK)	NUMBER(10,0)	NULL
PERSON_ID (FK)	NUMBER(10,0)	NULL
SPECIAL_COST_ID (FK)	NUMBER(10,0)	NULL
BUS_ORG_ID (FK)	NUMBER(10,0)	NULL
PAYEE_BUS_ORG_ID (FK)	NUMBER(10,0)	NULL
COA_CODE_ID (FK)	NUMBER(10,0)	NULL
HCPCS_MOD_ID (FK)	NUMBER(10,0)	NULL
WG_ID (FK)	NUMBER(10,0)	NULL
CREATOR_STAFF_ID (FK)	NUMBER(10,0)	NULL
PYMT_ACCRUAL_CODE_ID (FK)	NUMBER(10,0)	NULL
CONTACT_LOC_CD	CHAR(1)	NULL
PAYEE_BUS_NAME	VARCHAR2(50)	NULL
SVC_BUS_NAME	VARCHAR2(50)	NULL
PAYING_CNTY_CD	CHAR(2)	NULL
PYMT_INV_NUM	VARCHAR2(20)	NULL
PAYEE_CNTY_VEN_NUM	VARCHAR2(20)	NULL
SVC_CNTY_VEN_NUM	VARCHAR2(20)	NULL
PYMT_TAX_1099_CD	VARCHAR2(1)	NULL
APPROVAL_DT	DATE	NULL
PYMT_STATUS_CD	VARCHAR2(2)	NULL
PYMT_DOC_PTS	NUMBER(10,0)	NULL
PYMT_SVC_START_DT	DATE	NULL
PYMT_SVC_END_DT	DATE	NULL
PYMT_PER_DIEM	NUMBER(12,2)	NULL
IVE_REIMB_IND	VARCHAR2(1)	NULL
PYMT_INV_DT	DATE	NULL
PYMT_REQ_AMT	NUMBER(12,2)	NULL
PYMT_PAID_AMT	NUMBER(12,2)	NULL
PYMT_DESC	VARCHAR2(255)	NULL
PYMT_DT	DATE	NULL
PYMT_RATE	NUMBER(14,4)	NULL
PYMT_SEAGR_UNITS	NUMBER(12,2)	NULL
PYMT_SUBMITTED_DT	DATE	NULL
PYMT_TYPE_CD	VARCHAR2(1)	NULL
PYMT_UNITS	NUMBER(12,2)	NULL
UNIT_TYPE_CD	VARCHAR2(2)	NULL
CNTY_DEFINED_DT	DATE	NULL
CONFIRMATION_AMT	NUMBER(12,2)	NULL
CONFIRMATION_NUM	VARCHAR2(20)	NULL
PROV_LIC_NUM	VARCHAR2(10)	NULL
IVE_SUB_CD	VARCHAR2(1)	NULL
CONTRACT_NUM	VARCHAR2(20)	NULL
PYMT_CREATED_DT	DATE	NULL
CNTY_DEFINED_FLD	VARCHAR2(40)	NULL
LAST_CHGD_BY	NUMBER(10,0)	NOT NULL
LAST_CHGD_DT	DATE	NOT NULL

PYMT_COMMENT_XREF (3320)

PYMT_COMMENT_XREF_ID (PK)	NUMBER(10,0)	NOT NULL
PAYMENT_ID (FK)	NUMBER(10,0)	NOT NULL
COMMENTS_LOG_ID (FK)	NUMBER(10,0)	NOT NULL
LAST_CHGD_BY	NUMBER(10,0)	NOT NULL
LAST_CHGD_DT	DATE	NOT NULL

PYMT_BATCH_XREF (3360)

PYMT_BATCH_XREF_ID (PK)	NUMBER(10,0)	NOT NULL
PYMT_BATCH_ID (FK)	NUMBER(10,0)	NOT NULL
PAYMENT_ID (FK)	NUMBER(10,0)	NOT NULL
LAST_CHGD_BY	NUMBER(10,0)	NOT NULL
LAST_CHGD_DT	DATE	NOT NULL

PYMT_BATCH (3350)

PYMT_BATCH_ID (PK)	NUMBER(10,0)	NOT NULL
OWNER_STAFF_ID (FK)	NUMBER(10,0)	NULL
PBATCH_CNT_AMT	NUMBER(12,2)	NULL
PBATCH_DESC	VARCHAR2(100)	NULL
PBATCH_SCH_WARR_DT	DATE	NULL
PBATCH_SUB_STAT_CD	VARCHAR2(2)	NULL
LAST_CHGD_BY	NUMBER(10,0)	NOT NULL
LAST_CHGD_DT	DATE	NOT NULL

PYMT_ACCRUAL_CODE (3330)

PYMT_ACCRUAL_CODE_ID (PK)	NUMBER(10,0)	NOT NULL
ACCRUAL_CODE	VARCHAR2(3)	NULL
ACCRUAL_DESC	VARCHAR2(100)	NULL
ACCRUAL_START_DT	DATE	NULL
ACCRUAL_END_DT	DATE	NULL
LAST_CHGD_BY	NUMBER(10,0)	NOT NULL
LAST_CHGD_DT	DATE	NOT NULL

CP_ALLEG_DETAIL (4355)

CP_ALLEG_DETAIL_ID (PK)	NUMBER(10,0)	NOT NULL
CP_ALLEG_ID (FK)	NUMBER(10,0)	NOT NULL
CP_ALLEG_DETAIL_CD	VARCHAR2(2)	NULL
LAST_CHGD_BY	NUMBER(10,0)	NOT NULL
LAST_CHGD_DT	DATE	NOT NULL

CP_ALLEG_APPEAL (4360)

CP_ALLEG_APPEAL_ID (PK)	NUMBER(10,0)	NOT NULL
CP_ALLEG_ID (FK)	NUMBER(10,0)	NOT NULL
APPEAL_VENUE_CD	VARCHAR2(1)	NULL
DECISION_DT	DATE	NULL
ALLEG_DETERM_IND	VARCHAR2(1)	NULL
LAST_CHGD_BY	NUMBER(10,0)	NOT NULL
LAST_CHGD_DT	DATE	NOT NULL

CP_RPT (4300)

CP_RPT_ID (PK)	NUMBER(10,0)	NOT NULL
WG_ID (FK)	NUMBER(10,0)	NOT NULL
PERSON_ID (FK)	NUMBER(10,0)	NULL
IMMINENT_DANGER_IND	VARCHAR2(1)	NULL
POLICE_REPORT_NUM	VARCHAR2(20)	NULL
CP_RPT_STATUS_CD	VARCHAR2(2)	NULL
NUM_CHILDREN	NUMBER(10,0)	NULL
MAND_REPORTER_IND	VARCHAR2(1)	NULL
CP_RPT_SOURCE_CD	VARCHAR2(2)	NULL
CP_RPT_END_DT	DATE	NULL
CP_RPT_END_REASON_CD	VARCHAR2(2)	NULL
MALT_DETERM_IND	VARCHAR2(1)	NULL
CP_SVCS_NEED_IND	VARCHAR2(1)	NULL
CP_SVCS_AGREE_IND	VARCHAR2(1)	NULL
FACILITY_RESP_IND	VARCHAR2(1)	NULL
INDV_RESP_IND	VARCHAR2(1)	NULL
REC_LIC_ACTION_IND	VARCHAR2(1)	NULL
CONCLUDE_COMMENTS	VARCHAR2(500)	NULL
APPEAL_DETERM_IND	VARCHAR2(1)	NULL
LAST_CHGD_BY	NUMBER(10,0)	NOT NULL
LAST_CHGD_DT	DATE	NOT NULL

CP_RECOMMENDED_SVCS (4320)

CP_REC_SVCS_ID (PK)	NUMBER(10,0)	NOT NULL
CP_RPT_ID (FK)	NUMBER(10,0)	NOT NULL
REC_SVCS_CD	VARCHAR2(2)	NULL
LAST_CHGD_BY	NUMBER(10,0)	NOT NULL
LAST_CHGD_DT	DATE	NOT NULL

CP_INIT_NOTIFICATION (4325)

CP_INIT_NOTIFY_ID (PK)	NUMBER(10,0)	NOT NULL
CP_RPT_ID (FK)	NUMBER(10,0)	NOT NULL
AGENCY_NOTIFY_CD	VARCHAR2(1)	NULL
NOTIFY_DT	DATE	NULL
NOTIFY_METHOD_CD	VARCHAR2(1)	NULL
NOTIFY_PERSON	VARCHAR2(50)	NULL
LAST_CHGD_BY	NUMBER(10,0)	NOT NULL
LAST_CHGD_DT	DATE	NOT NULL

CP_ALLEG (4350)

CP_ALLEG_ID (PK)	NUMBER(10,0)	NOT NULL
CP_RPT_ID (FK)	NUMBER(10,0)	NOT NULL
OFFENDER_ID (FK)	NUMBER(10,0)	NULL
VICTIM_ID (FK)	NUMBER(10,0)	NULL
NCANDS_REL_CD	VARCHAR2(2)	NULL
ALLEG_DETERM_IND	VARCHAR2(1)	NULL
ALLEG_DETERM_DT	DATE	NULL
ALLEG_SEVERITY_CD	VARCHAR2(1)	NULL
ALLEGATION_CD	VARCHAR2(1)	NULL
OFFENDER_DESC	VARCHAR2(65)	NULL
VICTIM_DESC	VARCHAR2(65)	NULL
EST_INCIDENT_DT	DATE	NULL
APPEAL_DETERM_IND	VARCHAR2(1)	NULL
LAST_CHGD_BY	NUMBER(10,0)	NOT NULL
LAST_CHGD_DT	DATE	NOT NULL

CP_RPT_TRACK (4305)

CP_RPT_TRACK_ID (PK)	NUMBER(10,0)	NOT NULL
CP_RPT_ID (FK)	NUMBER(10,0)	NOT NULL
TRACK_EFF_DT	DATE	NOT NULL
TRACK_CD	VARCHAR2(1)	NULL
INV_TRACK_REASON_CD	VARCHAR2(2)	NULL
TRACK_SWITCH_RSN_CD	VARCHAR2(2)	NULL
TRACK_COMMENTS	VARCHAR2(255)	NULL
LAST_CHGD_BY	NUMBER(10,0)	NOT NULL
LAST_CHGD_DT	DATE	NOT NULL

CP_RPT_FACILITY (4310)

CP_RPT_FACILITY_ID (PK)	NUMBER(10,0)	NOT NULL
CP_RPT_ID (FK)	NUMBER(10,0)	NOT NULL
BUS_ORG_ID (FK)	NUMBER(10,0)	NULL
PROV_LIC_NUM	VARCHAR2(10)	NULL
LICENSE_TYPE_CD	CHAR(2)	NULL
LAST_CHGD_BY	NUMBER(10,0)	NOT NULL
LAST_CHGD_DT	DATE	NOT NULL

CP_RPT_VICTIM (4315)

CP_RPT_VICTIM_ID (PK)	NUMBER(10,0)	NOT NULL
CP_RPT_ID (FK)	NUMBER(10,0)	NOT NULL
PERSON_ID (FK)	NUMBER(10,0)	NULL
CT_APPOINT_REP_IND	VARCHAR2(1)	NULL
CM_LIVING_SIT_CD	VARCHAR2(1)	NULL
CHILD_BEHAVIOR_IND	VARCHAR2(1)	NULL
PETITION_DT	DATE	NULL
NO_INTERVW_REASON_CD	VARCHAR2(1)	NULL
JUV_PETITION_IND	VARCHAR2(1)	NULL
LAST_CHGD_BY	NUMBER(10,0)	NOT NULL
LAST_CHGD_DT	DATE	NOT NULL

CP_FAMILY_CONDITIONS (4330)

CP_FAMILY_COND_ID (PK)	NUMBER(10,0)	NOT NULL
CP_RPT_ID (FK)	NUMBER(10,0)	NOT NULL
FAMILY_COND_CD	VARCHAR2(1)	NULL
LAST_CHGD_BY	NUMBER(10,0)	NOT NULL
LAST_CHGD_DT	DATE	NOT NULL

(3,3)

WG_CLOSE (2265)

WG_CLOSE_ID (PK)	NUMBER(10,0)	NOT NULL
WG_ID	NUMBER(10,0)	NULL
STAFF_ID (FK)	NUMBER(10,0)	NULL
CATEGORY	VARCHAR2(30)	NULL
CLIENT_NAME	VARCHAR2(50)	NULL
MISSING_DATA	VARCHAR2(150)	NULL
ENTRY_SCREEN	VARCHAR2(100)	NULL

WG_RELATIONSHIP (425)

WG_RELATIONSHIP_ID (PK)	NUMBER(10,0)	NOT NULL
WG_ID (FK)	NUMBER(10,0)	NOT NULL
WG_ID2 (FK)	NUMBER(10,0)	NOT NULL
WG_ASSOCIATION_DT	DATE	NULL
LAST_CHGD_BY	NUMBER(10,0)	NOT NULL
LAST_CHGD_DT	DATE	NOT NULL

CPR_FACTOR (935)

FACTOR_ID (PK)	NUMBER(10,0)	NOT NULL
FACTOR_DESC	VARCHAR2(80)	NULL
NO_RISK	VARCHAR2(300)	NULL
LOW_RISK	VARCHAR2(300)	NULL
MOD_RISK	VARCHAR2(500)	NULL
HIGH_RISK	VARCHAR2(500)	NULL
CHILD_REL_IND	CHAR(1)	NULL
LAST_CHGD_BY	NUMBER(10,0)	NOT NULL
LAST_CHGD_DT	DATE	NOT NULL

CPR_DETAIL_FACTOR (945)

CPR_DET_FACTOR_ID (PK)	NUMBER(10,0)	NOT NULL
CPR_DETAIL_ID (FK)	NUMBER(10,0)	NULL
FACTOR_ID (FK)	NUMBER(10,0)	NULL
RISK_CD	CHAR(1)	NULL
DOC_SUPPORTING	VARCHAR2(3800)	NULL
LAST_CHGD_BY	NUMBER(10,0)	NULL
LAST_CHGD_DT	DATE	NULL

CPR_ASSESS_DETAIL (940)

CPR_DETAIL_ID (PK)	NUMBER(10,0)	NOT NULL
CPR_ASSESS_ID (FK)	NUMBER(10,0)	NULL
PERSON_ID (FK)	NUMBER(10,0)	NULL
FAMILY_REC_IND	CHAR(1)	NULL
LAST_CHGD_BY	NUMBER(10,0)	NULL
LAST_CHGD_DT	DATE	NULL

CPR_ASSESSMENT (930)

CPR_ASSESS_ID (PK)	NUMBER(10,0)	NOT NULL
WG_ID (FK)	NUMBER(10,0)	NOT NULL
STAFF_ID (FK)	NUMBER(10,0)	NULL
ASSESS_DT	DATE	NULL
START_DT	DATE	NULL
FINALIZE_DT	DATE	NULL
CPRISK_COMMENTS	VARCHAR2(1900)	NULL
OVERALL_RISK_CD	CHAR(1)	NULL
REC_SVCS_COMMENTS	VARCHAR2(1900)	NULL
LAST_CHGD_BY	NUMBER(10,0)	NULL
LAST_CHGD_DT	DATE	NULL

WORK_GROUP (400)

WG_ID (PK)	NUMBER(10,0)	NOT NULL
UNIT_ID (FK)	NUMBER(10,0)	NOT NULL
FOLDER_ID (FK)	NUMBER(10,0)	NOT NULL
WG_LABEL	VARCHAR2(80)	NOT NULL
START_DT	DATE	NOT NULL
SUBPROG_ID (FK)	NUMBER(10,0)	NULL
END_DT	DATE	NULL
CNTY_CASE_NUM	VARCHAR2(10)	NULL
APP_STATUS_CD	CHAR(1)	NULL
APP_COMPL_DT	DATE	NULL
APP_SIGNED_DT	DATE	NULL
APP_NUM	CHAR(2)	NULL
SPECIAL_STUDIES_CD	CHAR(2)	NULL
REASON_ENDED_CD	CHAR(2)	NULL
DESTRUCTION_DT	DATE	NULL
READ_RESTRICT_CD	CHAR(1)	NULL
CURR_STATUS_CD	CHAR(1)	NULL
ASSIGNED_IND	CHAR(1)	NULL
WG_TYPE_CD	CHAR(1)	NULL
CNTY_OF_SVC_CD	CHAR(2)	NOT NULL
CONVERSION_CD	CHAR(1)	NULL
CNTY_FIN_RESP_CD	CHAR(2)	NOT NULL
WG_DESC	VARCHAR2(40)	NULL
CNTY_DESTDT_MOD_IND	VARCHAR2(1)	NULL
LAST_CHGD_BY	NUMBER(10,0)	NOT NULL
LAST_CHGD_DT	DATE	NOT NULL

WG_SWITCH (1875)

WG_SWITCH_ID (PK)	NUMBER(10,0)	NOT NULL
WG_ID (FK)	NUMBER(10,0)	NOT NULL
SWITCH_REASON_CD	CHAR(2)	NOT NULL
OTHER_REASON	VARCHAR2(64)	NULL
WG_SWITCH_COMMENTS	VARCHAR2(255)	NULL
SWITCH_TYPE_CD	VARCHAR2(1)	NULL
SWITCH_EFF_DT	DATE	NULL
LAST_CHGD_BY	NUMBER(10,0)	NULL
LAST_CHGD_DT	DATE	NULL

PERSON_WG_XREF (525)

PERSON_WG_ID (PK)	NUMBER(10,0)	NOT NULL
PERSON_ID (FK)	NUMBER(10,0)	NOT NULL
WG_ID (FK)	NUMBER(10,0)	NOT NULL
END_DT	DATE	NULL
FAMILY_MEMBER_NUM	CHAR(2)	NULL
VIOLENCE_IND	CHAR(1)	NULL
ASSOC_STATUS_CD	CHAR(1)	NULL
DISASSOC_REASON_CD	CHAR(2)	NULL
TENN_IND	CHAR(1)	NULL
TENN_TYPE_CD	CHAR(1)	NULL
TENN_DT	DATE	NULL
LICENSING_ROLE_CD	CHAR(1)	NULL
LAST_CHGD_BY	NUMBER(10,0)	NOT NULL
LAST_CHGD_DT	DATE	NOT NULL

STAFF_LOGGED_ON (2240)

STAFF_ID (PK)	NUMBER(10,0)	NOT NULL
ORA_ID	NUMBER(10,0)	NULL
LOGGED_ON_DT	DATE	NULL

RECIPIENT_FEES (655)

RECIPIENT_FEES_ID (PK)	NUMBER(10,0)	NOT NULL
WG_ID (FK)	NUMBER(10,0)	NOT NULL
REC_PERSON_ID (FK)	NUMBER(10,0)	NOT NULL
RESP_PERSON_ID (FK)	NUMBER(10,0)	NULL
SUBPROG_ID (FK)	NUMBER(10,0)	NULL
BRASS_SVC_ID (FK)	NUMBER(10,0)	NULL
CNTY_SUBSVC_ID (FK)	NUMBER(10,0)	NULL
FEE_AMT	NUMBER(10,2)	NULL
FEE_ASSESSBASIS_CD	CHAR(2)	NULL
FEE_START_DT	DATE	NULL
FEE_END_DT	DATE	NULL
FEE_COMMENTS	VARCHAR2(400)	NULL
LAST_CHGD_BY	NUMBER(10,0)	NOT NULL
LAST_CHGD_DT	DATE	NOT NULL

CONTPLCMT (2900)

CONTPLCMT_ID (PK)	NUMBER(10,0)	NOT NULL
PERSON_ID (FK)	NUMBER(10,0)	NOT NULL
CONTPLCMT_START_DT	DATE	NULL
CONTPLCMT_END_DT	DATE	NULL
REASON_DISCHRG_CD	VARCHAR2(2)	NULL
START_DT_TRAN_DT	DATE	NULL
END_DT_TRAN_DT	DATE	NULL
STRUCT_CTKR_FAM_CD	VARCHAR2(1)	NULL
TARGET_POP_CD	VARCHAR2(1)	NULL
RCOND_FINALIZE_DT	DATE	NULL
MIN_LENGTH_IND	VARCHAR2(1)	NULL
SSI_SSA_FFS_IND	VARCHAR2(1)	NULL
SUP_AGCY_CD	VARCHAR2(1)	NULL
SUP_TRIBE_CD	VARCHAR2(3)	NULL
SOLE_RSN_DSABL_IND	VARCHAR2(1)	NULL
AFCARS_PLCD_FROM_CD	VARCHAR2(1)	NULL
AFCARS_PLCD_BY_CD	VARCHAR2(1)	NULL
LAST_CHGD_BY	NUMBER(10,0)	NOT NULL
LAST_CHGD_DT	DATE	NOT NULL

CONTPLCMT_PPLAN (2925)

CONTPLCMT_PPLAN_ID (PK)	NUMBER(10,0)	NOT NULL
CONTPLCMT_ID (FK)	NUMBER(10,0)	NOT NULL
PRIMARY_PPLAN_IND	VARCHAR2(1)	NULL
PRM_PLAN_CD	VARCHAR2(1)	NULL
ACHIEVE_DT	DATE	NULL
LAST_CHGD_BY	NUMBER(10,0)	NOT NULL
LAST_CHGD_DT	DATE	NOT NULL

CONTPLCMT_REVIEW (2920)

CONTPLCMT_REVIEW_ID (PK)	NUMBER(10,0)	NOT NULL
CONTPLCMT_ID (FK)	NUMBER(10,0)	NOT NULL
REVIEW_DT	DATE	NOT NULL
REVIEW_TYPE_CD	VARCHAR2(1)	NOT NULL
LAST_CHGD_BY	NUMBER(10,0)	NOT NULL
LAST_CHGD_DT	DATE	NOT NULL

STAFF_PROCESS (170)

STAFF_PROCESS_ID (PK)	NUMBER(10,0)	NOT NULL
STAFF_ID (FK)	NUMBER(10,0)	NOT NULL
PROCESS_ID	NUMBER(10,0)	NULL

CONTPLCMT_AUTH (2905)

CONTPLCMT_AUTH_ID (PK)	NUMBER(10,0)	NOT NULL
CONTPLCMT_ID (FK)	NUMBER(10,0)	NOT NULL
PLACE_AUTH_CD	VARCHAR2(1)	NOT NULL
PLACE_AUTH_EFF_DT	DATE	NOT NULL
LAST_CHGD_BY	NUMBER(10,0)	NOT NULL
LAST_CHGD_DT	DATE	NOT NULL

CONTPLCMT_RCOND (2910)

CONTPLCMT_RCOND_ID (PK)	NUMBER(10,0)	NOT NULL
CONTPLCMT_ID (FK)	NUMBER(10,0)	NOT NULL
RMV_COND_CD	VARCHAR2(2)	NULL
PRIMARY_RCOND_IND	VARCHAR2(1)	NULL
LAST_CHGD_BY	NUMBER(10,0)	NOT NULL
LAST_CHGD_DT	DATE	NOT NULL

CONTPLCMT_CTKR (2915)

CONTPLCMT_CTKR_ID (PK)	NUMBER(10,0)	NOT NULL
CONTPLCMT_ID (FK)	NUMBER(10,0)	NOT NULL
PERSON_ID (FK)	NUMBER(10,0)	NOT NULL
LAST_CHGD_BY	NUMBER(10,0)	NOT NULL
LAST_CHGD_DT	DATE	NOT NULL

FC_EXTENSION (2975)

FC_EXTENSION_ID (PK)	NUMBER(10,0)	NOT NULL
CONTPLCMT_ID (FK)	NUMBER(10,0)	NOT NULL
FC_EXTENSION_CD	VARCHAR2(2)	NULL
FC_EXT_EFF_DT	DATE	NULL
FC_EXT_END_DT	DATE	NULL
LAST_CHGD_BY	NUMBER(10,0)	NOT NULL
LAST_CHGD_DT	DATE	NOT NULL

FC_EXT_REVIEW (2980)

FC_EXT_REVIEW_ID (PK)	NUMBER(10,0)	NOT NULL
CONTPLCMT_ID (FK)	NUMBER(10,0)	NOT NULL
REVIEW_STAFF_ID (FK)	NUMBER(10,0)	NULL
FC_EXT_REVIEW_DT	DATE	NULL
LAST_CHGD_BY	NUMBER(10,0)	NOT NULL
LAST_CHGD_DT	DATE	NOT NULL

LOCATION (120)

LOCATION_ID (PK)	NUMBER(10,0)	NOT NULL
DESCRIPTION	VARCHAR2(65)	NOT NULL
DESC_LINE_2	VARCHAR2(40)	NULL
DESC_LINE_3	VARCHAR2(40)	NULL
CITY	VARCHAR2(25)	NULL
STATE_CD	CHAR(2)	NULL
ZIP_CODE	CHAR(5)	NULL
ZIP_CODE_EXT	VARCHAR2(4)	NULL
CNTY_CD	CHAR(2)	NOT NULL
ADDR_1	VARCHAR2(100)	NULL
ADDR_2	VARCHAR2(100)	NULL
ADDR_3	VARCHAR2(100)	NULL
LAST_CHGD_DT	DATE	NOT NULL
LAST_CHGD_BY	NUMBER(10,0)	NOT NULL

DEX_PARAM_CD (3530)

DEX_PARAM_CD_ID (PK)	NUMBER(10,0)	NOT NULL
DEX_PARAM_NAME	VARCHAR2(65)	NULL
DEX_PARAM_TYPE	VARCHAR2(65)	NULL
DEX_INTERFACE_CD	VARCHAR2(2)	NULL
DEX_CONFIG_FILE	VARCHAR2(65)	NULL
DEX_PARAM_DESC	VARCHAR2(65)	NULL
DEX_PARAM_PSWD	VARCHAR2(1)	NOT NULL
DEX_SYS_PARAM_IND	VARCHAR2(1)	NOT NULL
SORT_ORDER	NUMBER(10,0)	NULL
DEX_PARAM_TIME	VARCHAR2(1)	NULL
LAST_CHGD_BY	NUMBER(10,0)	NOT NULL
LAST_CHGD_DT	DATE	NOT NULL

PYMT_VENDOR_IMP (3370)

PYMT_VENDOR_ID (PK)	NUMBER(10,0)	NOT NULL
CNTY_VEN_NUM	VARCHAR2(20)	NULL
LAST_CHGD_BY	NUMBER(10,0)	NOT NULL
LAST_CHGD_DT	DATE	NOT NULL

DEX_PARAM (3520)

DEX_PARAM_ID (PK)	NUMBER(10,0)	NOT NULL
DEX_PARAM_CD_ID (FK)	NUMBER(10,0)	NOT NULL
DEX_PARAM_VAL	VARCHAR2(100)	NULL
LAST_CHGD_BY	NUMBER(10,0)	NOT NULL
LAST_CHGD_DT	DATE	NOT NULL

DEX_ELIG_FILES (3510)

DEX_ELIG_FILES_ID (PK)	NUMBER(10,0)	NOT NULL
UPDATE_ELIG_FILE	VARCHAR2(65)	NULL
LAST_CHGD_BY	NUMBER(10,0)	NOT NULL
LAST_CHGD_DT	DATE	NOT NULL

SW_CASE_ACCESS (3000)

SW_CASE_ACCESS_ID (PK)	NUMBER(10,0)	NOT NULL
FOLDER_ID (FK)	NUMBER(10,0)	NOT NULL
WG_ID (FK)	NUMBER(10,0)	NOT NULL
SW_INDEX_ID	NUMBER(10,0)	NOT NULL
REQUESTING_CNTY_CD	CHAR(2)	NOT NULL
REQUESTING_STAFF_ID	NUMBER(10,0)	NOT NULL
AUTHORIZED_STAFF_ID (FK)	NUMBER(10,0)	NULL
TITLE_OF_COURTESY	VARCHAR2(6)	NULL
FIRST_NAME	VARCHAR2(20)	NOT NULL
MIDDLE_NAME	VARCHAR2(20)	NULL
LAST_NAME	VARCHAR2(30)	NOT NULL
NAME_SUFFIX	VARCHAR2(5)	NULL
PHONE_1	VARCHAR2(14)	NULL
TITLE	VARCHAR2(40)	NULL
APPROVING_STAFF_ID (FK)	NUMBER(10,0)	NULL
REQUEST_DT	DATE	NOT NULL
RESPONSE_DT	DATE	NULL
ACCESS_APPROVED_IND	VARCHAR2(1)	NOT NULL
ACCESS_END_DT	DATE	NULL
ACCESS_START_DT	DATE	NULL
PASSWORD	VARCHAR2(40)	NULL
REQUEST_REASON_CD	VARCHAR2(1)	NULL
LAST_CHGD_BY	NUMBER(10,0)	NOT NULL
LAST_CHGD_DT	DATE	NOT NULL

PLCMT_LOC_PARENT (2940)

PLCMT_LOC_PARENT_ID (PK)	NUMBER(10,0)	NOT NULL
PLCMT_LOC_HIST_ID (FK)	NUMBER(10,0)	NOT NULL
PERSON_ID (FK)	NUMBER(10,0)	NOT NULL
RELATION_ID (FK)	NUMBER(10,0)	NULL
LAST_CHGD_BY	NUMBER(10,0)	NOT NULL
LAST_CHGD_DT	DATE	NOT NULL

PLCMT_LOC_HIST (2935)

PLCMT_LOC_HIST_ID (PK)	NUMBER(10,0)	NOT NULL
PLCMT_LOC_ID (FK)	NUMBER(10,0)	NOT NULL
WG_ID (FK)	NUMBER(10,0)	NULL
BUS_ORG_ID (FK)	NUMBER(10,0)	NULL
LOC_DESC	VARCHAR2(100)	NULL
LOC_EFF_DT	DATE	NULL
LOC_SETTING_CD	VARCHAR2(2)	NULL
LAST_CHGD_BY	NUMBER(10,0)	NOT NULL
LAST_CHGD_DT	DATE	NOT NULL

HC_PROV (630)

HC_PROV_ID (PK)	NUMBER(10,0)	NOT NULL
FIELD_PRACTICE_CD	CHAR(2)	NULL
PROV_NAME	VARCHAR2(100)	NULL
HCPROV_PHONE	VARCHAR2(14)	NULL
CLINIC_NAME	VARCHAR2(100)	NULL
CLINIC_ADDRESS	VARCHAR2(100)	NULL
HCPROV_COMMENTS	VARCHAR2(100)	NULL
LAST_CHGD_BY	NUMBER(10,0)	NOT NULL
LAST_CHGD_DT	DATE	NOT NULL

PLCMT_LOC (2930)

PLCMT_LOC_ID (PK)	NUMBER(10,0)	NOT NULL
PERSON_ID (FK)	NUMBER(10,0)	NOT NULL
LOC_REASON_CD	VARCHAR2(2)	NULL
LOC_END_REASON_CD	VARCHAR2(2)	NULL
MONTHLY_FC_ASSIST	NUMBER(10,2)	NULL
SCHOOL_DIST_NUM (FK)	CHAR(4)	NULL
LOC_START_DT	DATE	NULL
LOC_END_DT	DATE	NULL
COURTESY_SUPVN_IND	VARCHAR2(1)	NULL
ICPC_REC_ST_CD	VARCHAR2(2)	NULL
LOC_END_DT_TRAN_DT	DATE	NULL
LOC_START_DT_TRAN_DT	DATE	NULL
DISRUPT_RSN_CD	VARCHAR2(1)	NULL
DISRUPT_DETAIL_CD	VARCHAR2(1)	NULL
LAST_CHGD_BY	NUMBER(10,0)	NOT NULL
LAST_CHGD_DT	DATE	NOT NULL

PERSON_HC_PROV (635)

PERSON_HC_PROV_ID (PK)	NUMBER(10,0)	NOT NULL
HC_PROV_ID (FK)	NUMBER(10,0)	NULL
PERSON_ID (FK)	NUMBER(10,0)	NULL
PRIMARY_PHYS_IND	CHAR(1)	NULL
LAST_CHGD_BY	NUMBER(10,0)	NOT NULL
LAST_CHGD_DT	DATE	NOT NULL

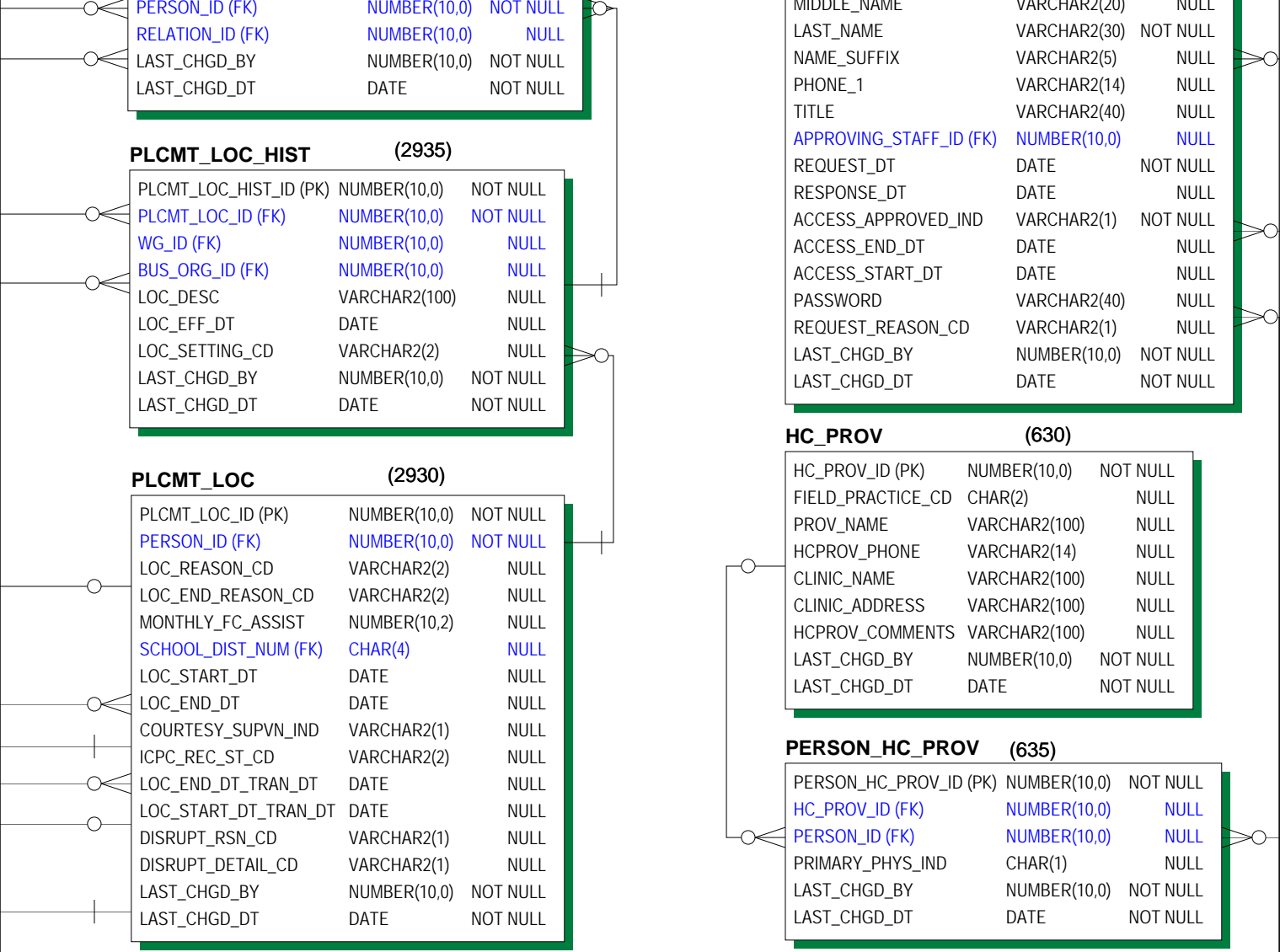

(3,6)

PAYMENT_IMP

(3375)

PAYMENT_IMP_ID (PK)	NUMBER(10,0)	NOT NULL
PYMT_IMP_CNTY_ID	NUMBER(10,0)	NULL
PYMT_IMP_STATUS_CD	VARCHAR2(2)	NULL
PYMT_IMP_STATUS_DT	DATE	NULL
PYMT_IMP_STATUS_CMT	VARCHAR2(200)	NULL
PYMT_IMP_VNDR_CMT	VARCHAR2(200)	NULL
ORIG_PAYMENT_ID	NUMBER(10,0)	NULL
PAYMENT_ID	NUMBER(10,0)	NULL
SA_GROUP_ID	NUMBER(10,0)	NULL
SVC_ARRANGEMENT_ID	NUMBER(10,0)	NULL
SUBPROG_ID	NUMBER(10,0)	NULL
BRASS_SVC_ID	NUMBER(10,0)	NULL
CNTY_SUBSVC_ID	NUMBER(10,0)	NULL
PERSON_ID	NUMBER(10,0)	NULL
SPECIAL_COST_ID	NUMBER(10,0)	NULL
SVC_BUS_ORG_ID	NUMBER(10,0)	NULL
PAYEE_BUS_ORG_ID	NUMBER(10,0)	NULL
COA_CODE_ID	NUMBER(10,0)	NULL
HCPCS_MOD_ID	NUMBER(10,0)	NULL
WG_ID	NUMBER(10,0)	NULL
CREATOR_STAFF_ID	NUMBER(10,0)	NULL
APPROVAL_STAFF_ID	NUMBER(10,0)	NULL
PYMT_ACCRUAL_CODE_ID	NUMBER(10,0)	NULL
CONTACT_LOC_CD	CHAR(1)	NULL
SVC_BUS_NAME	VARCHAR2(50)	NULL
PAYEE_BUS_NAME	VARCHAR2(50)	NULL
PAYING_CNTY_CD	CHAR(2)	NULL
PYMT_INV_NUM	VARCHAR2(20)	NULL
PAYEE_CNTY_VEN_NUM	VARCHAR2(20)	NULL
SVC_CNTY_VEN_NUM	VARCHAR2(20)	NULL
PYMT_TAX_1099_CD	VARCHAR2(1)	NULL
APPROVAL_DT	DATE	NULL
PYMT_STATUS_CD	VARCHAR2(2)	NULL
PYMT_DOC_PTS	NUMBER(10,0)	NULL
PYMT_SVC_START_DT	DATE	NULL
PYMT_SVC_END_DT	DATE	NULL
PYMT_PER_DIEM	NUMBER(12,2)	NULL
IVE_REIMB_IND	VARCHAR2(1)	NULL
PYMT_INV_DT	DATE	NULL
PYMT_REQ_AMT	NUMBER(12,2)	NULL
PYMT_PAID_AMT	NUMBER(12,2)	NULL
PYMT_DESC	VARCHAR2(255)	NULL
PYMT_DT	DATE	NULL
PYMT_RATE	NUMBER(14,4)	NULL
PYMT_SEAGR_UNITS	NUMBER(12,2)	NULL
PYMT_SUBMITTED_DT	DATE	NULL
PYMT_TYPE_CD	VARCHAR2(1)	NULL
PYMT_UNITS	NUMBER(12,2)	NULL
UNIT_TYPE_CD	VARCHAR2(2)	NULL
CNTY_DEFINED_DT	DATE	NULL
CONFIRMATION_AMT	NUMBER(12,2)	NULL
CONFIRMATION_NUM	VARCHAR2(20)	NULL
PROV_LIC_NUM	VARCHAR2(10)	NULL
IVE_SUB_CD	VARCHAR2(1)	NULL
CONTRACT_NUM	VARCHAR2(20)	NULL
PYMT_CREATED_DT	DATE	NULL
CNTY_DEFINED_FLD	VARCHAR2(40)	NULL
LAST_CHGD_BY	NUMBER(10,0)	NOT NULL
LAST_CHGD_DT	DATE	NOT NULL

PYMT_REQ_EXPORT

(3900)

PYMT_REQ_EXPORT_ID (PK)	NUMBER(10,0)	NOT NULL
APPROVAL_STAFF_ID (FK)	NUMBER(10,0)	NULL
CREATOR_STAFF_ID (FK)	NUMBER(10,0)	NULL
BRASS_SVC_ID (FK)	NUMBER(10,0)	NULL
CNTY_SUBSVC_ID (FK)	NUMBER(10,0)	NULL
COA_CODE_ID (FK)	NUMBER(10,0)	NULL
HCPCS_MOD_ID (FK)	NUMBER(10,0)	NULL
PAYEE_BUS_ORG_ID (FK)	NUMBER(10,0)	NULL
PAYMENT_ID (FK)	NUMBER(10,0)	NOT NULL
PERSON_ID (FK)	NUMBER(10,0)	NULL
PYMT_ACCRUAL_CODE_ID (FK)	NUMBER(10,0)	NULL
PYMT_BATCH_ID (FK)	NUMBER(10,0)	NOT NULL
SA_GROUP_ID (FK)	NUMBER(10,0)	NULL
SPECIAL_COST_ID (FK)	NUMBER(10,0)	NULL
SUBPROG_ID (FK)	NUMBER(10,0)	NULL
SVC_ARRANGEMENT_ID (FK)	NUMBER(10,0)	NULL
BUS_ORG_ID (FK)	NUMBER(10,0)	NULL
WG_ID (FK)	NUMBER(10,0)	NULL
ACCRUAL_CODE	VARCHAR2(3)	NULL
APPROVAL_DT	DATE	NULL
CNTY_DEFINED_DT	DATE	NULL
CNTY_DEFINED_FLD	VARCHAR2(40)	NULL
CNTY_PERSON_NUM	VARCHAR2(10)	NULL
COA_DESC	VARCHAR2(65)	NULL
COA_ELEMENT_1	VARCHAR2(10)	NULL
COA_ELEMENT_2	VARCHAR2(10)	NULL
COA_ELEMENT_3	VARCHAR2(10)	NULL
COA_ELEMENT_4	VARCHAR2(10)	NULL
COA_ELEMENT_5	VARCHAR2(10)	NULL
COA_ELEMENT_6	VARCHAR2(10)	NULL
COA_ELEMENT_7	VARCHAR2(10)	NULL
COA_ELEMENT_8	VARCHAR2(10)	NULL
COA_ELEMENT_9	VARCHAR2(10)	NULL
COA_ELEMENT_10	VARCHAR2(10)	NULL
COA_ELEMENT_11	VARCHAR2(10)	NULL
CONTACT_LOC_CD	CHAR(1)	NULL
CONTRACT_NUM	VARCHAR2(20)	NULL
CREATED_DT	DATE	NULL
FIRST_NAME	VARCHAR2(20)	NULL
IVE_REIMB_IND	VARCHAR2(1)	NULL
IVE_SUB_CD	VARCHAR2(1)	NULL
LAST_NAME	VARCHAR2(30)	NULL
MIDDLE_NAME	VARCHAR2(20)	NULL
NAME_SUFFIX	VARCHAR2(5)	NULL
PAYEE_BUS_NAME	VARCHAR2(50)	NULL
PAYEE_CNTY_VEN_NUM	VARCHAR2(20)	NULL
PAYING_CNTY_CD	CHAR(2)	NULL
PROV_LIC_NUM	VARCHAR2(10)	NULL
PYMT_DESC	VARCHAR2(255)	NULL
PYMT_DOC_PTS	NUMBER(10,0)	NULL
PYMT_INV_NUM	VARCHAR2(20)	NULL
PYMT_INV_DT	DATE	NULL
PYMT_PER_DIEM	NUMBER(12,2)	NULL
PYMT_RATE	NUMBER(14,4)	NULL
PYMT_REQ_AMT	NUMBER(12,2)	NULL
PYMT_SEAGR_UNITS	NUMBER(12,2)	NULL
PYMT_SVC_START_DT	DATE	NULL
PYMT_SVC_END_DT	DATE	NULL
PYMT_TAX_1099_CD	VARCHAR2(1)	NULL
PYMT_UNITS	NUMBER(12,2)	NULL
SCH_WARR_DT	DATE	NULL

(3,7)

DOCUMENT (300)

DOCUMENT_ID (PK)	NUMBER(10,0)	NOT NULL
TEMPL_ID	NUMBER(10,0)	NULL
WG_ID (FK)	NUMBER(10,0)	NULL
STAFF_ID (FK)	NUMBER(10,0)	NOT NULL
CREATED_DT	DATE	NOT NULL
DOCUMENT_STATUS_CD	CHAR(1)	NOT NULL
DESCRIPTION	VARCHAR2(65)	NULL
DOCUMENT_TYPE_CD	CHAR(1)	NULL
DOCUMENT	BLOB	NULL
FINALIZE_DT	DATE	NULL
LASTEDITED_DT	DATE	NULL
HEADER_PRINT_CD	CHAR(1)	NULL
LAST_CHGD_BY	NUMBER(10,0)	NOT NULL
LAST_CHGD_DT	DATE	NOT NULL

DOCU_ANSWER_SET (352)

DOCU_ANSWER_SET_ID (PK)	NUMBER(10,0)	NOT NULL
DOCU_ANSWER_SET_DESC	VARCHAR2(85)	NOT NULL
STATE_DEFINED_IND	CHAR(1)	NULL
LAST_CHGD_BY	NUMBER(10,0)	NOT NULL
LAST_CHGD_DT	DATE	NOT NULL

DOCU_ANSWER (362)

DOCU_ANSWER_ID (PK)	NUMBER(10,0)	NOT NULL
DOCU_ANSWER_SET_ID (FK)	NUMBER(10,0)	NOT NULL
DOCU_ANSWER	VARCHAR2(120)	NOT NULL
SORT_ORDER	NUMBER(10,0)	NULL
LAST_CHGD_BY	NUMBER(10,0)	NOT NULL
LAST_CHGD_DT	DATE	NOT NULL

DOCU_PROMPT (382)

DOCU_PROMPT_ID (PK)	NUMBER(10,0)	NOT NULL
DT_DTF_XREF_ID (FK)	NUMBER(10,0)	NOT NULL
DOCU_ANSWER_SET_ID (FK)	NUMBER(10,0)	NOT NULL
PROMPT_TEXT	VARCHAR2(256)	NOT NULL
LAST_CHGD_BY	NUMBER(10,0)	NOT NULL
LAST_CHGD_DT	DATE	NOT NULL

DOCU_HEADERS_FOOTERS (392)

DOCU_HEADERS_FTRS_ID (PK)	NUMBER(10,0)	NOT NULL
SSIS_DOCUMENT_ID (FK)	NUMBER(10,0)	NOT NULL
TMPL_HEADER_ID (FK)	NUMBER(10,0)	NULL
TMPL_FOOTER_ID (FK)	NUMBER(10,0)	NULL
TMPL_TITLE_FOOTER_ID (FK)	NUMBER(10,0)	NULL
TMPL_TITLE_ID (FK)	NUMBER(10,0)	NULL
LAST_CHGD_BY	NUMBER(10,0)	NOT NULL
LAST_CHGD_DT	DATE	NOT NULL

DOCU_CONDITION (372)

DOCU_CONDITION_ID (PK)	NUMBER(10,0)	NOT NULL
DOCUMENT_TMPL_ID (FK)	NUMBER(10,0)	NOT NULL
DT_DTF_XREF_ID_DRVR (FK)	NUMBER(10,0)	NULL
DT_DTF_XREF_ID_AFFCT (FK)	NUMBER(10,0)	NULL
ENTITY_NAME_DRIVER	VARCHAR2(200)	NOT NULL
ENTITY_NAME_AFFECTED	VARCHAR2(200)	NOT NULL
GT_LT_EQUAL_CD	VARCHAR2(5)	NOT NULL
CONDITION_VAL	VARCHAR2(200)	NULL
LAST_CHGD_BY	NUMBER(10,0)	NOT NULL
LAST_CHGD_DT	DATE	NOT NULL

DOCU_GRP_DOC_XREF (379)

DOCU_GRP_DOC_XREF_ID (PK)	NUMBER(10,0)	NOT NULL
DOCU_GROUP_ID (FK)	NUMBER(10,0)	NOT NULL
SSIS_DOCUMENT_ID (FK)	NUMBER(10,0)	NOT NULL
GRP_COMPLETE_IND	VARCHAR2(1)	NULL
LAST_CHGD_BY	NUMBER(10,0)	NOT NULL
LAST_CHGD_DT	DATE	NOT NULL

DOCU_GRP_FLD_XREF (378)

DOCU_GRP_FLD_XREF_ID (PK)	NUMBER(10,0)	NOT NULL
DOCU_GROUP_ID (FK)	NUMBER(10,0)	NOT NULL
DT_DTF_XREF_ID (FK)	NUMBER(10,0)	NOT NULL
READ_ONLY_IND	VARCHAR2(1)	NULL
DGFX_CAPTION	VARCHAR2(300)	NULL
CMP_TAG	NUMBER(10,0)	NULL
LOAD_ORDER	NUMBER(3,0)	NULL
CAPTION_TAG	NUMBER(10,0)	NULL
ELEM_ROW	NUMBER(10,0)	NULL
SECTION_TAG	VARCHAR2(10)	NULL
LAST_CHGD_BY	NUMBER(10,0)	NOT NULL
LAST_CHGD_DT	DATE	NOT NULL

DOCU_GROUP (377)

DOCU_GROUP_ID (PK)	NUMBER(10,0)	NOT NULL
DOCU_GROUP_PARENT_ID (FK)	NUMBER(10,0)	NULL
DOCUMENT_TMPL_ID (FK)	NUMBER(10,0)	NULL
ICON	NUMBER(3,0)	NULL
DG_CAPTION	VARCHAR2(100)	NULL
REQ_IND	VARCHAR2(1)	NULL
COMPLETE_IND	VARCHAR2(1)	NULL
GRP_CLASSNAME	VARCHAR2(30)	NULL
GRP_ORDER	NUMBER(3,0)	NULL
LAST_CHGD_BY	NUMBER(10,0)	NOT NULL
LAST_CHGD_DT	DATE	NOT NULL

EXTERN_DOC_LINKS (390)

EXTERN_DOC_LINKS_ID (PK)	NUMBER(10,0)	NOT NULL
EXT_NUM	VARCHAR2(20)	NULL
EXT_TITLE	VARCHAR2(200)	NOT NULL
DHS_AGENCY_IND	VARCHAR2(1)	NOT NULL
EXT_URL	VARCHAR2(500)	NOT NULL
EXT_DESC	VARCHAR2(500)	NOT NULL
LAST_CHGD_BY	NUMBER(10,0)	NOT NULL
LAST_CHGD_DT	DATE	NOT NULL

CARD_INFO (395)

CARD_INFO_ID (PK)	NUMBER(10,0)	NOT NULL
DO_SERVER_OBJECT	VARCHAR2(85)	NULL
DO_ACTIVE_VIEW	VARCHAR2(85)	NULL
CARD_CAPTION_FIELD	VARCHAR2(30)	NULL
KEY_FIELD_NAME	VARCHAR2(30)	NULL
CARD_FIELDLIST	VARCHAR2(1000)	NULL
CARD_HEIGHT	NUMBER(4,0)	NULL
CARD_WIDTH	NUMBER(4,0)	NULL
DISABLE_BUS_RULES	VARCHAR2(1)	NULL
LAST_CHGD_BY	NUMBER(10,0)	NOT NULL
LAST_CHGD_DT	DATE	NOT NULL

DT_TOOL_TAB_ROLE (5215)

DT_TOOL_TAB_ROLE_ID (PK)	NUMBER(10,0)	NOT NULL
DT_TOOL_TAB_ID (FK)	NUMBER(10,0)	NOT NULL
PERSON_DT_ROLE_CD	VARCHAR2(6)	NOT NULL
LAST_CHGD_BY	NUMBER(10,0)	NOT NULL
LAST_CHGD_DT	DATE	NOT NULL

DT_TAB_Q_SET_XREF (5220)

DT_TAB_Q_SET_XREF_ID (PK)	NUMBER(10,0)	NOT NULL
DT_TOOL_TAB_ID (FK)	NUMBER(10,0)	NOT NULL
DT_Q_SET_ID (FK)	NUMBER(10,0)	NOT NULL
DISPLAY_ARRANGE_CD	VARCHAR2(6)	NULL
SORT_ORDER	NUMBER(10,0)	NULL
LAST_CHGD_BY	NUMBER(10,0)	NOT NULL
LAST_CHGD_DT	DATE	NOT NULL

DT_Q_SET_ROLE (5225)

DT_Q_SET_ROLE_ID (PK)	NUMBER(10,0)	NOT NULL
DT_Q_SET_ID (FK)	NUMBER(10,0)	NOT NULL
PERSON_DT_ROLE_CD	VARCHAR2(6)	NOT NULL
LAST_CHGD_BY	NUMBER(10,0)	NOT NULL
LAST_CHGD_DT	DATE	NOT NULL

DT_ANSWER_SET (5230)

DT_ANSWER_SET_ID (PK)	NUMBER(10,0)	NOT NULL
DT_QUESTION_ID (FK)	NUMBER(10,0)	NOT NULL
ANSWER_SET_DESC	VARCHAR2(64)	NULL
DFT_ANSWER_SET_IND	VARCHAR2(1)	NULL
LAST_CHGD_BY	NUMBER(10,0)	NOT NULL
LAST_CHGD_DT	DATE	NOT NULL

DT_ANSWER (5235)

DT_ANSWER_ID (PK)	NUMBER(10,0)	NOT NULL
DT_ANSWER_SET_ID (FK)	NUMBER(10,0)	NOT NULL
CONDITION_SCORE	NUMBER(3,0)	NULL
ANSWER_SCORE	NUMBER(3,0)	NULL
ANSWER	VARCHAR2(512)	NULL
ANSWER_RANGE_LOW	NUMBER(5,0)	NULL
ANSWER_RANGE_HIGH	NUMBER(5,0)	NULL
ANSWER_HELP	VARCHAR2(1000)	NULL
EXCL_FROM_SCORE_IND	VARCHAR2(1)	NULL
SORT_ORDER	NUMBER(10,0)	NULL
OVERRIDE_CD	VARCHAR2(6)	NULL
APPROVAL_REQ_IND	VARCHAR2(1)	NULL
LAST_CHGD_BY	NUMBER(10,0)	NOT NULL
LAST_CHGD_DT	DATE	NOT NULL

TI_ANSWER (5310)

TI_ANSWER_ID (PK)	NUMBER(10,0)	NOT NULL
DT_QUESTION_ID (FK)	NUMBER(10,0)	NOT NULL
DT_ANSWER_ID (FK)	NUMBER(10,0)	NOT NULL
TI_PERSON_ID (FK)	NUMBER(10,0)	NULL
TI_TOOL_ID (FK)	NUMBER(10,0)	NOT NULL
TI_ANSWER_SCORE	NUMBER(3,0)	NULL
TI_ANSWER_TEXT	VARCHAR2(1024)	NULL
EXCL_FROM_SCORE_IND	VARCHAR2(1)	NOT NULL
PRIORITY_IND	CHAR(1)	NULL
LAST_CHGD_BY	NUMBER(10,0)	NOT NULL
LAST_CHGD_DT	DATE	NOT NULL

DT_TOOL_DECISION (5205)

DT_TOOL_DECISION_ID (PK)	NUMBER(10,0)	NOT NULL
DT_DECISION_TREE_ID (FK)	NUMBER(10,0)	NOT NULL
DECISION_DESC	VARCHAR2(128)	NULL
DECISION_COLUMN_CD	VARCHAR2(6)	NULL
DISPLAY_SEQ	NUMBER(10,0)	NULL
GRID_COLUMN_NBR	NUMBER(10,0)	NULL
PERSON_IND	VARCHAR2(1)	NULL
LAST_CHGD_BY	NUMBER(10,0)	NOT NULL
LAST_CHGD_DT	DATE	NOT NULL

DT_TOOL_TAB (5210)

DT_TOOL_TAB_ID (PK)	NUMBER(10,0)	NOT NULL
DT_TOOL_TEMPLATE_ID (FK)	NUMBER(10,0)	NOT NULL
TAB_DESC	VARCHAR2(32)	NULL
DT_Q_SET_SELECT_IND	VARCHAR2(1)	NULL
SORT_ORDER	NUMBER(10,0)	NULL
DFT_TO_DISABLED_IND	VARCHAR2(1)	NULL
LAST_CHGD_BY	NUMBER(10,0)	NOT NULL
LAST_CHGD_DT	DATE	NOT NULL

DT_COND_QUEST_XREF (5240)

DT_COND_QUEST_XRF_ID (PK)	NUMBER(10,0)	NOT NULL
DT_CONDITION_ID (FK)	NUMBER(10,0)	NOT NULL
DT_QUESTION_ID (FK)	NUMBER(10,0)	NOT NULL
LAST_CHGD_BY	NUMBER(10,0)	NOT NULL
LAST_CHGD_DT	DATE	NOT NULL

DT_D_TREE_QUEST_XREF (5245)

DT_DTREE_Q_XREF_ID (PK)	NUMBER(10,0)	NOT NULL
DT_DECISION_TREE_ID (FK)	NUMBER(10,0)	NOT NULL
DT_QUESTION_ID (FK)	NUMBER(10,0)	NOT NULL
LAST_CHGD_BY	NUMBER(10,0)	NOT NULL
LAST_CHGD_DT	DATE	NOT NULL

DT_Q_SET (5250)

DT_Q_SET_ID (PK)	NUMBER(10,0)	NOT NULL
DT_Q_SET_DESC	VARCHAR2(256)	NOT NULL
PANEL_TEXT	VARCHAR2(128)	NULL
PANEL_BORDER_IND	VARCHAR2(1)	NULL
LAST_CHGD_BY	NUMBER(10,0)	NOT NULL
LAST_CHGD_DT	DATE	NOT NULL

DT_QUESTION (5255)

DT_QUESTION_ID (PK)	NUMBER(10,0)	NOT NULL
DT_Q_SET_ID (FK)	NUMBER(10,0)	NOT NULL
SORT_ORDER	NUMBER(10,0)	NULL
QUESTION_PREFIX	VARCHAR2(5)	NULL
QUESTION	VARCHAR2(512)	NOT NULL
SHOW_SCORE_IND	CHAR(1)	NULL
DT_CONTROL_TYPE_CD	VARCHAR2(6)	NOT NULL
SHOW_ANS_TEXT_IND	VARCHAR2(1)	NULL
QUESTION_HELP	VARCHAR2(1000)	NULL
DFT_TO_DISABLED_IND	VARCHAR2(1)	NOT NULL
DFT_NOT_VISIBLE_IND	VARCHAR2(1)	NULL
LAST_CHGD_BY	NUMBER(10,0)	NOT NULL
LAST_CHGD_DT	DATE	NOT NULL

DT_DECISION_TREE (5200)

DT_DECISION_TREE_ID (PK)	NUMBER(10,0)	NOT NULL
DT_SQL_ID (FK)	NUMBER(10,0)	NULL
DT_TOOL_TEMPLATE_ID (FK)	NUMBER(10,0)	NOT NULL
YES_TREE_BRANCH_ID (FK)	NUMBER(10,0)	NULL
NO_TREE_BRANCH_ID (FK)	NUMBER(10,0)	NULL
BRANCH_DESC	VARCHAR2(128)	NULL
TEST_VALUE	VARCHAR2(32)	NULL
DECISION_CD	VARCHAR2(6)	NULL
ROOT_NODE_IND	CHAR(1)	NULL
DT_DECISION_TYPE_CD	VARCHAR2(2)	NULL
LAST_CHGD_BY	NUMBER(10,0)	NOT NULL
LAST_CHGD_DT	DATE	NOT NULL

DT_CONDITION (5265)

DT_CONDITION_ID (PK)	NUMBER(10,0)	NOT NULL
DT_CONDITION_SET_ID (FK)	NUMBER(10,0)	NOT NULL
DT_DECISION_TREE_ID (FK)	NUMBER(10,0)	NULL
CONDITION_DESC	VARCHAR2(256)	NULL
EVALUATION_SEQUENCE	NUMBER(5,0)	NULL
COMPARISON_OP_CD	VARCHAR2(6)	NOT NULL
TEST_VALUE	VARCHAR2(32)	NOT NULL
PLSQL_IND	VARCHAR2(1)	NULL
RUN_ON_OPEN_IND	VARCHAR2(1)	NULL
LAST_CHGD_BY	NUMBER(10,0)	NOT NULL
LAST_CHGD_DT	DATE	NOT NULL

DT_CONDITION_SET (5270)

DT_CONDITION_SET_ID (PK)	NUMBER(10,0)	NOT NULL
DT_QUESTION_ID (FK)	NUMBER(10,0)	NULL
DT_Q_SET_ID (FK)	NUMBER(10,0)	NULL
DT_TOOL_TAB_ID (FK)	NUMBER(10,0)	NULL
DT_TOOL_TEMPLATE_ID (FK)	NUMBER(10,0)	NOT NULL
DT_DECISION_TREE_ID (FK)	NUMBER(10,0)	NULL
CONDITION_SET_DESC	VARCHAR2(256)	NOT NULL
DT_DRIVER_TYPE_CD	VARCHAR2(6)	NOT NULL
EVENT_TYPE_CD	VARCHAR2(6)	NOT NULL
LAST_CHGD_BY	NUMBER(10,0)	NOT NULL
LAST_CHGD_DT	DATE	NOT NULL

DT_CONDITION_EFFECT (5260)

DT_CONDITION_EFF_ID (PK)	NUMBER(10,0)	NOT NULL
DT_CONDITION_ID (FK)	NUMBER(10,0)	NOT NULL
DT_Q_SET_ID (FK)	NUMBER(10,0)	NULL
DT_QUESTION_ID (FK)	NUMBER(10,0)	NULL
DT_TOOL_TEMPLATE_ID (FK)	NUMBER(10,0)	NULL
DT_DECISION_TREE_ID (FK)	NUMBER(10,0)	NULL
SSIS_MESSAGE_ID	NUMBER(10,0)	NULL
DT_TOOL_TAB_ID (FK)	NUMBER(10,0)	NULL
DT_ANSWER_SET_ID (FK)	NUMBER(10,0)	NULL
DT_ANSWER_ID (FK)	NUMBER(10,0)	NULL
CONDITION_EFF_DESC	VARCHAR2(256)	NULL
DT_AFFECTED_TYPE_CD	VARCHAR2(6)	NULL
RUN_SEQUENCE	NUMBER(5,0)	NULL
EFFECT_CD	VARCHAR2(6)	NOT NULL
LAST_CHGD_BY	NUMBER(10,0)	NOT NULL
LAST_CHGD_DT	DATE	NOT NULL

DT_TOOL_TEMPL_ROLE (5275)

DT_TOOL_TEMPL_ROLE_ID (PK)	NUMBER(10,0)	NOT NULL
DT_TOOL_TEMPLATE_ID (FK)	NUMBER(10,0)	NOT NULL
PERSON_DT_ROLE_CD	VARCHAR2(6)	NOT NULL
ROLE_REQUIRED_IND	VARCHAR2(1)	NULL
LIMIT_TO_ONE_IND	VARCHAR2(1)	NULL
LAST_CHGD_BY	NUMBER(10,0)	NOT NULL
LAST_CHGD_DT	DATE	NOT NULL

DT_TOOL_TEMPLATE (5280)

DT_TOOL_TEMPLATE_ID (PK)	NUMBER(10,0)	NOT NULL
WG_BASED_TOOL_IND	VARCHAR2(1)	NOT NULL
DT_TEMPLATE_DESC	VARCHAR2(64)	NOT NULL
DTT_VERSION	VARCHAR2(32)	NOT NULL
DT_TEMPL_STATUS_CD	VARCHAR2(6)	NOT NULL
DT_TOOL_TYPE_CD	VARCHAR2(2)	NOT NULL
LAST_CHGD_BY	NUMBER(10,0)	NOT NULL
LAST_CHGD_DT	DATE	NOT NULL

DT_TOOL_HEADER (5285)

DT_TOOL_HEADER_ID (PK)	NUMBER(10,0)	NOT NULL
DT_TOOL_TEMPLATE_ID (FK)	NUMBER(10,0)	NOT NULL
HEADER_COLUMN_CD	VARCHAR2(6)	NOT NULL
HEADER_DESCRIPTION	VARCHAR2(32)	NULL
DISPLAY_SEQ	NUMBER(10,0)	NOT NULL
GRID_COLUMN_NBR	NUMBER(10,0)	NOT NULL
LAST_CHGD_BY	NUMBER(10,0)	NOT NULL
LAST_CHGD_DT	DATE	NOT NULL

TI_TOOL (5300)

TI_TOOL_ID (PK)	NUMBER(10,0)	NOT NULL
DT_TOOL_TEMPLATE_ID (FK)	NUMBER(10,0)	NOT NULL
WG_ID	NUMBER(10,0)	NULL
STAFF_ID	NUMBER(10,0)	NULL
APPROVE_STAFF_ID (FK)	NUMBER(10,0)	NULL
TOOL_CREATE_DT	DATE	NULL
TOOL_ASSESSMENT_DT	DATE	NULL
TOOL_FINALIZE_DT	DATE	NULL
TOOL_STATUS_CD	VARCHAR2(2)	NULL
LAST_CHGD_BY	NUMBER(10,0)	NOT NULL
LAST_CHGD_DT	DATE	NOT NULL

TI_DECISION (5305)

TI_DECISION_ID (PK)	NUMBER(10,0)	NOT NULL
TI_TOOL_ID (FK)	NUMBER(10,0)	NOT NULL
TI_PERSON_ID (FK)	NUMBER(10,0)	NULL
DT_DECISION_TREE_ID (FK)	NUMBER(10,0)	NULL
CALCULATED_SCORE	NUMBER(5,0)	NULL
DECISION_CD	VARCHAR2(6)	NULL
OVERRIDE_CD	VARCHAR2(6)	NULL
LAST_CHGD_BY	NUMBER(10,0)	NOT NULL
LAST_CHGD_DT	DATE	NOT NULL

STAFF (100)

STAFF_ID (PK)	NUMBER(10,0)	NOT NULL
TITLE_OF_COURTESY	VARCHAR2(6)	NULL
FIRST_NAME	VARCHAR2(20)	NOT NULL
MIDDLE_NAME	VARCHAR2(20)	NULL
LAST_NAME	VARCHAR2(30)	NOT NULL
NAME_SUFFIX	VARCHAR2(5)	NULL
PHONE_1	VARCHAR2(14)	NULL
CNTY_STAFF_NUM	VARCHAR2(10)	NULL
READ_ACCESS_CD	CHAR(1)	NOT NULL
USER_ID	VARCHAR2(8)	NULL
PASSWORD	VARCHAR2(40)	NULL
STAFF_ROLE_ID (FK)	NUMBER(10,0)	NOT NULL
COUNTY_EMPL_CD	CHAR(1)	NULL
TITLE	VARCHAR2(40)	NULL
TEMP_ROLE_ID (FK)	NUMBER(10,0)	NULL
TEMPROLE_START_DT	DATE	NULL
TEMPROLE_END_DT	DATE	NULL
WG_READWRITE_IND	CHAR(1)	NULL
CNTY_OF_SVC_CD	CHAR(2)	NOT NULL
STAFF_ACTIVITY_IND	CHAR(1)	NULL
INTAKE_ACC_REST_CD	CHAR(1)	NULL
INTAKE_UNIT_ID	NUMBER(10,0)	NULL
PASSWORD_CHG_DT	DATE	NULL
EMAIL_ADDRESS	VARCHAR2(100)	NULL
COUNTY_ENTITY_CD	VARCHAR2(1)	NULL
MHAI_IND	VARCHAR2(1)	NULL
RTC_IND	VARCHAR2(1)	NULL
RTC_HOST_CNTY_CD	VARCHAR2(2)	NULL
DOC_CREDENTIALS	VARCHAR2(40)	NULL
AGENCY_CONTACT_IND	VARCHAR2(1)	NULL
LAST_CHGD_BY	NUMBER(10,0)	NOT NULL
LAST_CHGD_DT	DATE	NOT NULL

STAFF_PROGRAM (155)

STAFF_PROGRAM_ID (PK)	NUMBER(10,0)	NOT NULL
STAFF_ID (FK)	NUMBER(10,0)	NOT NULL
BRASS_PROGRAM_ID (FK)	NUMBER(10,0)	NOT NULL
LAST_CHGD_BY	NUMBER(10,0)	NOT NULL
LAST_CHGD_DT	DATE	NOT NULL

UNIT_STAFF_XREF (130)

STAFF_ID (PK)(FK)	NUMBER(10,0)	NOT NULL
UNIT_ID (PK)(FK)	NUMBER(10,0)	NOT NULL
LAST_CHGD_BY	NUMBER(10,0)	NOT NULL
LAST_CHGD_DT	DATE	NOT NULL

STAFF_UNIT (115)

UNIT_ID (PK)	NUMBER(10,0)	NOT NULL
DEPT_ID (FK)	NUMBER(10,0)	NOT NULL
LOCATION_ID (FK)	NUMBER(10,0)	NULL
UNIT_NAME	VARCHAR2(50)	NOT NULL
READ_RESTRICT_CD	CHAR(1)	NOT NULL
LAST_CHGD_BY	NUMBER(10,0)	NOT NULL
LAST_CHGD_DT	DATE	NOT NULL

UNIT_SUPERVISOR (150)

UNIT_ID (PK)(FK)	NUMBER(10,0)	NOT NULL
SUPERVISOR_ID (PK)(FK)	NUMBER(10,0)	NOT NULL
LAST_CHGD_BY	NUMBER(10,0)	NOT NULL
LAST_CHGD_DT	DATE	NOT NULL

STAFF_WG (125)

STAFF_WG_ID (PK)	NUMBER(10,0)	NOT NULL
STAFF_ID (FK)	NUMBER(10,0)	NOT NULL
WG_ID (FK)	NUMBER(10,0)	NOT NULL
START_DT	DATE	NOT NULL
END_DT	DATE	NULL
PRIMARY_IND	CHAR(1)	NULL
LAST_CHGD_BY	NUMBER(10,0)	NOT NULL
LAST_CHGD_DT	DATE	NOT NULL

STAFF_CLAIM_QUAL (3260)

STAFF_CLAIM_QUAL_ID (PK)	NUMBER(10,0)	NOT NULL
STAFF_ID (FK)	NUMBER(10,0)	NOT NULL
CLAIM_CAT_CD	VARCHAR2(1)	NULL
CLAIM_IND	VARCHAR2(1)	NULL
STAFF_CLAIM_ST_DT	DATE	NULL
STAFF_CLAIM_END_DT	DATE	NULL
QUAL_TYPE_CD	VARCHAR2(1)	NULL
LAST_CHGD_BY	NUMBER(10,0)	NOT NULL
LAST_CHGD_DT	DATE	NOT NULL

APPROVAL (1945)

APPROVAL_ID (PK)	NUMBER(10,0)	NOT NULL
STAFF_ID (FK)	NUMBER(10,0)	NULL
APPROVE_STAT_CD	CHAR(1)	NULL
APPROVE_STAT_DT	DATE	NULL
APPROVAL_COMMENTS	VARCHAR2(400)	NULL
AUTHENTICATION	VARCHAR2(40)	NULL
REQ_STAFF_ID (FK)	NUMBER(10,0)	NULL
LAST_CHGD_BY	NUMBER(10,0)	NOT NULL
LAST_CHGD_DT	DATE	NOT NULL

DEPT_STAFF_XREF (135)

STAFF_ID (PK)(FK)	NUMBER(10,0)	NOT NULL
DEPT_ID (PK)(FK)	NUMBER(10,0)	NOT NULL
LAST_CHGD_BY	NUMBER(10,0)	NOT NULL
LAST_CHGD_DT	DATE	NOT NULL

DEPARTMENT (110)

DEPT_ID (PK)	NUMBER(10,0)	NOT NULL
DEPARTMENT_NAME	VARCHAR2(50)	NOT NULL
CNTY_CD	CHAR(2)	NOT NULL
LAST_CHGD_BY	NUMBER(10,0)	NOT NULL
LAST_CHGD_DT	DATE	NOT NULL

STAFF_ROLE (205)

STAFF_ROLE_ID (PK)	NUMBER(10,0)	NOT NULL
STAFF_ROLE_DESC	VARCHAR2(50)	NOT NULL
LAST_CHGD_BY	NUMBER(10,0)	NOT NULL
LAST_CHGD_DT	DATE	NOT NULL

ROLE_ACTIVITY (210)

STAFF_ROLE_ID (PK)(FK)	NUMBER(10,0)	NOT NULL
ACTIVITY_ID (PK)(FK)	NUMBER(10,0)	NOT NULL
LAST_CHGD_BY	NUMBER(10,0)	NOT NULL
LAST_CHGD_DT	DATE	NOT NULL

ACTIVITY (200)

ACTIVITY_ID (PK)	NUMBER(10,0)	NOT NULL
ACTIVITY_DESC	VARCHAR2(30)	NOT NULL
LAST_CHGD_BY	NUMBER(10,0)	NOT NULL
LAST_CHGD_DT	DATE	NOT NULL

CNTY_APRPT_RESULTS

CNTY_CD	CHAR(2)	NOT NULL
WG_LABEL	VARCHAR2(80)	NULL
WG_ID	NUMBER(10,0)	NULL
WG_START_DT	DATE	NULL
AP_RPT_STATUS_CD	VARCHAR2(2)	NULL
AP_RPT_END_DT	DATE	NULL
LEAD_AGENCY_IND	VARCHAR2(1)	NULL
APPEAL_DETERM_CD	VARCHAR2(2)	NULL
AP_RPT_ID	NUMBER(10,0)	NULL
AP_ALLEGATION_CD	VARCHAR2(2)	NULL
VICTIM_ID	NUMBER(10,0)	NULL
V_LAST_NAME	VARCHAR2(30)	NULL
V_MIDDLE_NAME	VARCHAR2(20)	NULL
V_FIRST_NAME	VARCHAR2(20)	NULL
V_NAME_SUFFIX	VARCHAR2(5)	NULL
OFFENDER_ID	NUMBER(10,0)	NULL
O_LAST_NAME	VARCHAR2(30)	NULL
O_MIDDLE_NAME	VARCHAR2(20)	NULL
O_FIRST_NAME	VARCHAR2(20)	NULL
O_NAME_SUFFIX	VARCHAR2(5)	NULL
ALLEG_DETERM_CD	VARCHAR2(2)	NULL
PERSON1_NEU_DESC	VARCHAR2(50)	NULL
DETERMINED_IND	CHAR(1)	NULL
V_SW_INDEX_ID	NUMBER(10,0)	NULL
O_SW_INDEX_ID	NUMBER(10,0)	NULL

PERSON_INCOME (650)

PERSON_INCOME_ID (PK)	NUMBER(10,0)	NOT NULL
PERSON_ID (FK)	NUMBER(10,0)	NOT NULL
GROSS_WAGES_AMT	NUMBER(10,2)	NULL
SELF_EMPL_AMT	NUMBER(10,2)	NULL
FARM_AMT	NUMBER(10,2)	NULL
SS_RSDI_AMT	NUMBER(10,2)	NULL
SSI_AMT	NUMBER(10,2)	NULL
DIV_INT_RENT_AMT	NUMBER(10,2)	NULL
GEN_ASSIST_AMT	NUMBER(10,2)	NULL
PENSIONS_ANN_AMT	NUMBER(10,2)	NULL
UNEMPLOYMENT_AMT	NUMBER(10,2)	NULL
WORKERS_COMP_AMT	NUMBER(10,2)	NULL
ALIMONY_AMT	NUMBER(10,2)	NULL
CHILD_SUPPORT_AMT	NUMBER(10,2)	NULL
VET_PENSION_AMT	NUMBER(10,2)	NULL
OTHER_AMT	NUMBER(10,2)	NULL
OTHER_NAME	VARCHAR2(20)	NULL
INCOME_VFCN_DT	DATE	NULL
LAST_CHGD_BY	NUMBER(10,0)	NOT NULL
LAST_CHGD_DT	DATE	NOT NULL

WRKSRV_ERR

COMPUTER	CHAR(16)	NULL
ERROR_DT	CHAR(24)	NULL
ERROR_NUM	CHAR(11)	NULL
CLIENTS	CHAR(5)	NULL
USER_NAME	CHAR(16)	NULL
USER_ID	CHAR(13)	NULL
ALIAS_NAME	CHAR(13)	NULL
ERROR_MESSAGE	CHAR(254)	NULL

(4,6)

SGR_PAYMENT (4205)

SGR_PAYMENT_ID (PK)	NUMBER(10,0)	NOT NULL
STATE_RPT_ID (FK)	NUMBER(10,0)	NOT NULL
PAYMENT_ID (FK)	NUMBER(10,0)	NULL
PYMT_DT	DATE	NULL
BRASS_SVC_ID (FK)	NUMBER(10,0)	NOT NULL
PYMT_SEAGR_UNITS	NUMBER(12,2)	NOT NULL
PYMT_PAID_AMT	NUMBER(12,2)	NOT NULL
LAST_CHGD_BY	NUMBER(10,0)	NOT NULL
LAST_CHGD_DT	DATE	NOT NULL

SGR_TIME_RECORD (4210)

SGR_TIME_RECORD_ID (PK)	NUMBER(10,0)	NOT NULL
STATE_RPT_ID (FK)	NUMBER(10,0)	NOT NULL
TIME_RECORD_ID (FK)	NUMBER(10,0)	NULL
ACTIVITY_DT	DATE	NULL
BRASS_SVC_ID (FK)	NUMBER(10,0)	NOT NULL
DURATION	NUMBER(10,0)	NULL
LAST_CHGD_BY	NUMBER(10,0)	NOT NULL
LAST_CHGD_DT	DATE	NOT NULL

SGR_REV_DEF_TOTS (4235)

SGR_REV_DEF_TOTS_ID (PK)	NUMBER(10,0)	NOT NULL
SGR_REVENUE_CD	VARCHAR2(1)	NOT NULL
DHS_ENTRY_NUM	VARCHAR2(4)	NOT NULL
REV_DESC	VARCHAR2(65)	NOT NULL
REV_ORDER	NUMBER(10,0)	NOT NULL
SGR_YEAR	VARCHAR2(4)	NOT NULL
LAST_CHGD_BY	NUMBER(10,0)	NOT NULL
LAST_CHGD_DT	DATE	NOT NULL

SGR_REV_TOTS_XREF (4240)

SGR_REV_TOTS_XREF_ID (PK)	NUMBER(10,0)	NOT NULL
SGR_REV_DEF_TOTS_ID (FK)	NUMBER(10,0)	NOT NULL
SGR_REV_DEF_DET_ID (FK)	NUMBER(10,0)	NOT NULL
LAST_CHGD_BY	NUMBER(10,0)	NOT NULL
LAST_CHGD_DT	DATE	NOT NULL

SGR_REV_DETAIL (4230)

SGR_REV_DETAIL_ID (PK)	NUMBER(10,0)	NOT NULL
SGR_REV_MASTER_ID (FK)	NUMBER(10,0)	NOT NULL
DHS_ENTRY_NUM	VARCHAR2(4)	NOT NULL
REV_DESC	VARCHAR2(65)	NOT NULL
REV_ORDER	NUMBER(10,0)	NOT NULL
REV_AMOUNT	NUMBER(12,2)	NULL
REV_DESC_EDIT_IND	VARCHAR2(1)	NOT NULL
LAST_CHGD_BY	NUMBER(10,0)	NOT NULL
LAST_CHGD_DT	DATE	NOT NULL

SGR_REV_MASTER (4225)

SGR_REV_MASTER_ID (PK)	NUMBER(10,0)	NOT NULL
STATE_RPT_ID (FK)	NUMBER(10,0)	NOT NULL
SGR_REVENUE_CD	VARCHAR2(1)	NOT NULL
DHS_ENTRY_NUM	VARCHAR2(4)	NOT NULL
REV_DESC	VARCHAR2(65)	NOT NULL
REV_ORDER	NUMBER(10,0)	NOT NULL
LAST_CHGD_BY	NUMBER(10,0)	NOT NULL
LAST_CHGD_DT	DATE	NOT NULL

SVC_BUS_NAME	VARCHAR2(50)	NULL
SVC_CNTY_VEN_NUM	VARCHAR2(20)	NULL
UNIT_TYPE_CD	VARCHAR2(2)	NULL
LAST_CHGD_BY	NUMBER(10,0)	NOT NULL
LAST_CHGD_DT	DATE	NOT NULL

SGR_RPT (4230)

SGR_RPT_ID (PK)	NUMBER(10,0)	NOT NULL
STATE_RPT_ID (FK)	NUMBER(10,0)	NOT NULL
SS_FUND_RPT_LN1	NUMBER(12,2)	NULL
SS_STAFF_LN8	NUMBER(12,2)	NULL
TOT_STAFF_TIME	NUMBER(12,2)	NULL
SGR_STAFF_RATE	NUMBER(12,6)	NULL
SGR_TOT_STFF_EXP_ADJ	NUMBER(12,2)	NULL
LAST_CHGD_BY	NUMBER(10,0)	NOT NULL
LAST_CHGD_DT	DATE	NOT NULL

SGR_REV_DEF_DETAIL (4245)

SGR_REV_DEF_DET_ID (PK)	NUMBER(10,0)	NOT NULL
SGR_REV_DEF_MASTR_ID (FK)	NUMBER(10,0)	NOT NULL
DHS_ENTRY_NUM	VARCHAR2(4)	NOT NULL
REV_DESC	VARCHAR2(65)	NOT NULL
REV_DESC_EDIT_IND	VARCHAR2(1)	NOT NULL
REV_ORDER	NUMBER(10,0)	NOT NULL
LAST_CHGD_BY	NUMBER(10,0)	NOT NULL
LAST_CHGD_DT	DATE	NOT NULL

SGR_REV_DEF_MASTER (4250)

SGR_REV_DEF_MASTR_ID (PK)	NUMBER(10,0)	NOT NULL
SGR_REVENUE_CD	VARCHAR2(1)	NOT NULL
DHS_ENTRY_NUM	VARCHAR2(4)	NOT NULL
REV_DESC	VARCHAR2(65)	NOT NULL
REV_ORDER	NUMBER(10,0)	NOT NULL
SGR_YEAR	VARCHAR2(4)	NOT NULL
LAST_CHGD_BY	NUMBER(10,0)	NOT NULL
LAST_CHGD_DT	DATE	NOT NULL

SGR_BRASS_DETAIL (4215)

SGR_BRASS_DETAIL_ID (PK)	NUMBER(10,0)	NOT NULL
SGR_BRASS_LINE_ID (FK)	NUMBER(10,0)	NOT NULL
VALUE_TYPE_CD	VARCHAR2(2)	NOT NULL
SGR_EXP_PUR_SVC	NUMBER(12,2)	NULL
SGR_UNITS_PUR_SVC	NUMBER(12,4)	NULL
SGR_HOURS_STAFF_SVC	NUMBER(12,4)	NULL
SGR_STAFF_EXPENSE	NUMBER(12,4)	NULL
SGR_DIR_HRS_STFF_SVC	NUMBER(12,4)	NULL
SGR_DIR_STFF_EXPENSE	NUMBER(12,4)	NULL
SGR_TOT_EXPENSE	NUMBER(12,4)	NULL
LAST_CHGD_BY	NUMBER(10,0)	NOT NULL
LAST_CHGD_DT	DATE	NOT NULL

SGR_BRASS_LINE (4220)

SGR_BRASS_LINE_ID (PK)	NUMBER(10,0)	NOT NULL
STATE_RPT_ID (FK)	NUMBER(10,0)	NOT NULL
BRASS_SVC_ID (FK)	NUMBER(10,0)	NOT NULL
LAST_CHGD_BY	NUMBER(10,0)	NOT NULL
LAST_CHGD_DT	DATE	NOT NULL

(4,7) **DOCUMENT_CAT (365)**

DOCUMENT_CAT_ID (PK)	NUMBER(10,0)	NOT NULL
DOCU_CATEGORY_DESC	VARCHAR2(65)	NOT NULL
STATE_DEFINED_IND	CHAR(1)	NULL
LAST_CHGD_BY	NUMBER(10,0)	NOT NULL
LAST_CHGD_DT	DATE	NOT NULL

SSIS_DOCUMENT (375)

SSIS_DOCUMENT_ID (PK)	NUMBER(10,0)	NOT NULL
DOCUMENT_TMPL_ID (FK)	NUMBER(10,0)	NOT NULL
WG_ID (FK)	NUMBER(10,0)	NULL
PERSON_ID (FK)	NUMBER(10,0)	NULL
STAFF_ID (FK)	NUMBER(10,0)	NOT NULL
AD_WARD_EVENT_ID	NUMBER(10,0)	NULL
DOCUMENT_DESC	VARCHAR2(100)	NULL
CREATION_DT	DATE	NOT NULL
FINALIZE_DT	DATE	NULL
LASTEDITED_DT	DATE	NULL
DOCUMENT_STATUS_CD	CHAR(1)	NOT NULL
SETUP_COMPL_IND	VARCHAR2(1)	NULL
LAST_CHGD_BY	NUMBER(10,0)	NOT NULL
LAST_CHGD_DT	DATE	NOT NULL

DOCUMENT_TMPL (350)

DOCUMENT_TMPL_ID (PK)	NUMBER(10,0)	NOT NULL
DOCUMENT_CAT_ID (FK)	NUMBER(10,0)	NOT NULL
TMPL_NAME	VARCHAR2(100)	NOT NULL
TMPL_DESC	VARCHAR2(4000)	NULL
TMPL_GRP_CD	VARCHAR2(2)	NOT NULL
DOCUMENT_NUM	VARCHAR2(20)	NULL
TMPL_FORMAT_CD	VARCHAR2(2)	NULL
HTML_SOURCE	BLOB	NULL
TMPL_STATUS_CD	VARCHAR2(2)	NOT NULL
ALLOW_JAVASCRIPT_IND	VARCHAR2(1)	NULL
TMPL_CREATED_DT	DATE	NOT NULL
TMPL_STATUS_DT	DATE	NOT NULL
TMPL_HEADER_ID (FK)	NUMBER(10,0)	NULL
TMPL_FOOTER_ID (FK)	NUMBER(10,0)	NULL
TMPL_TITLE_ID (FK)	NUMBER(10,0)	NULL
TMPL_STYLE_SHEET_ID (FK)	NUMBER(10,0)	NULL
TMPL_TITLE_FOOTER_ID (FK)	NUMBER(10,0)	NULL
TMPL_DEPLOY_STAT_CD	VARCHAR2(1)	NULL
DOCU_TYPE_CD	VARCHAR2(2)	NOT NULL
ALLOW_TITLE_IND	VARCHAR2(1)	NULL
ALLOW_HEADER_IND	VARCHAR2(1)	NULL
ALLOW_TITLE_FTR_IND	VARCHAR2(1)	NULL
ALLOW_FOOTER_IND	VARCHAR2(1)	NULL
LAST_CHGD_BY	NUMBER(10,0)	NOT NULL
LAST_CHGD_DT	DATE	NOT NULL

DOCUMENT_DATA (370)

DOCUMENT_DATA_ID (PK)	NUMBER(10,0)	NOT NULL
DOCU_DATA_PARENT_ID (FK)	NUMBER(10,0)	NULL
SSIS_DOCUMENT_ID (FK)	NUMBER(10,0)	NOT NULL
DT_DTF_XREF_ID (FK)	NUMBER(10,0)	NOT NULL
KEY_ID	NUMBER(10,0)	NULL
RESULT_VAL	CLOB	NULL
LEGACY_VAL	BLOB	NULL
KEY_VALUE	VARCHAR2(21)	NULL
LAST_CHGD_BY	NUMBER(10,0)	NOT NULL
LAST_CHGD_DT	DATE	NOT NULL

DOCU_TMPL_FIELD (360)

DOCU_TMPL_FIELD_ID (PK)	NUMBER(10,0)	NOT NULL
DISPLAY_LABEL	VARCHAR2(65)	NOT NULL
XPATH	VARCHAR2(256)	NULL
CONTROL_TYPE_CD	VARCHAR2(6)	NULL
LIST_DOS_NAME	VARCHAR2(50)	NULL
DB_FIELD	VARCHAR2(30)	NULL
LIST_VIEW_NAME	VARCHAR2(50)	NULL
ENTITY_NM_ALLOW_IND	VARCHAR2(1)	NULL
TREE_PARENT_ID (FK)	NUMBER(10,0)	NULL
TREE_SEQUENCE	NUMBER(3,0)	NULL
TMPL_FLD_TYPE_CD	VARCHAR2(6)	NULL
DATA_VIEW_NAME	VARCHAR2(50)	NULL
DATA_DOS_NAME	VARCHAR2(50)	NULL
TMPL_FIELD_HINT	VARCHAR2(500)	NULL
CLIENT_CONTROL_WIDTH	NUMBER(3,0)	NULL
CREATE_ON_NEW_IND	VARCHAR2(1)	NULL
CLIENT_ONLY_IND	VARCHAR2(1)	NULL
SVC_PLAN_ALLOW_IND	VARCHAR2(1)	NULL
STATE_ONLY_IND	VARCHAR2(1)	NULL
DTF_ACTIVE_IND	VARCHAR2(1)	NULL
DOCU_TYPE_CD	VARCHAR2(2)	NULL
CARD_INFO_ID (FK)	NUMBER(10,0)	NULL
DEFAULT_IND	VARCHAR2(1)	NULL
LAST_CHGD_BY	NUMBER(10,0)	NOT NULL
LAST_CHGD_DT	DATE	NOT NULL

DOCU_TMPL_DTF_XREF (355)

DT_DTF_XREF_ID (PK)	NUMBER(10,0)	NOT NULL
DOCUMENT_TMPL_ID (FK)	NUMBER(10,0)	NOT NULL
DOCU_TMPL_FIELD_ID (FK)	NUMBER(10,0)	NOT NULL
ENTITY_NAME	VARCHAR2(200)	NULL
REQUIRED_IND	VARCHAR2(1)	NULL
USER_SELECT_IND	VARCHAR2(1)	NULL
TMPL_DATE_FORMAT_CD	VARCHAR2(2)	NULL
TBL_IND	VARCHAR2(1)	NULL
INPUT_FIELD_DEF	VARCHAR2(4000)	NULL
TMPL_STAFF_TYPE_CD	VARCHAR2(2)	NULL
SVC_PLAN_IND	VARCHAR2(1)	NULL
FILTER_FIELD_DEF	VARCHAR2(4000)	NULL
LAST_CHGD_BY	NUMBER(10,0)	NOT NULL
LAST_CHGD_DT	DATE	NOT NULL

DOCU_IMAGE (385)

DOCU_IMAGE_ID (PK)	NUMBER(10,0)	NOT NULL
DT_DTF_XREF_ID (FK)	NUMBER(10,0)	NULL
DOCU_BLOB	BLOB	NOT NULL
DOCU_IMG_NAME	VARCHAR2(50)	NOT NULL
LAST_CHGD_BY	NUMBER(10,0)	NOT NULL
LAST_CHGD_DT	DATE	NOT NULL

DOCU_REQUIREMENT (380)

DOCU_REQUIREMENT_ID (PK)	NUMBER(10,0)	NOT NULL
DOCUMENT_TMPL_ID (FK)	NUMBER(10,0)	NULL
DOCU_REQUIREMENT_CD	VARCHAR2(1)	NULL
LAST_CHGD_BY	NUMBER(10,0)	NOT NULL
LAST_CHGD_DT	DATE	NOT NULL

MEDICAL_INSURANCE (435)

MEDICAL_INS_ID (PK)	NUMBER(10,0)	NOT NULL
FOLDER_ID (FK)	NUMBER(10,0)	NULL
POLICY_NUM	VARCHAR2(15)	NOT NULL
INS_COMPANY_NAME	VARCHAR2(50)	NOT NULL
START_DT	DATE	NOT NULL
END_DT	DATE	NULL
POLICY HOLDER_ID (FK)	NUMBER(10,0)	NULL
GROUP_NUM	VARCHAR2(20)	NULL
HEALTH_PLAN_TYPE_CD	CHAR(1)	NULL
PHONE_1	VARCHAR2(14)	NULL
PRIOR_AUTH_PHONE	VARCHAR2(14)	NULL
LAST_CHGD_BY	NUMBER(10,0)	NOT NULL
LAST_CHGD_DT	DATE	NOT NULL

POLICY_MEMBER (440)

POLICY_MEMBER_ID (PK)	NUMBER(10,0)	NOT NULL
MEDICAL_INS_ID (FK)	NUMBER(10,0)	NULL
PERSON_ID (FK)	NUMBER(10,0)	NULL
POLICY_NUM	VARCHAR2(15)	NULL
PRIMARY_IND	CHAR(1)	NULL
LAST_CHGD_BY	NUMBER(10,0)	NOT NULL
LAST_CHGD_DT	DATE	NOT NULL

COMMON_MESSAGE (3810)

COMMON_MESSAGE_ID (PK)	NUMBER(10,0)	NOT NULL
COMMON_MSG_TYPE_CD	VARCHAR2(2)	NULL
COMMON_MSG_NUM	VARCHAR2(10)	NULL
SHORT_MSG	VARCHAR2(400)	NULL
LONG_MSG	VARCHAR2(4000)	NULL
LAST_CHGD_BY	NUMBER(10,0)	NOT NULL
LAST_CHGD_DT	DATE	NOT NULL

DOC_PT_RATE (1487)

DOC_PT_RATE_ID (PK)	NUMBER(10,0)	NOT NULL
YEAR	NUMBER(10,0)	NULL
POINT_RATE	NUMBER(12,2)	NULL
LAST_CHGD_BY	NUMBER(10,0)	NOT NULL
LAST_CHGD_DT	DATE	NOT NULL

SEAGR_CONV (3800)

SEAGR_CONV_ID (PK)	NUMBER(10,0)	NOT NULL
BRASS_SVC_ID (FK)	NUMBER(10,0)	NULL
HCPCS_MOD_ID (FK)	NUMBER(10,0)	NULL
UNIT_TYPE_CD	VARCHAR2(2)	NULL
SEAGR_MULTIPLIER	NUMBER(7,4)	NULL
CLIENT_IND	VARCHAR2(1)	NULL
SC_START_DT	DATE	NULL
SC_END_DT	DATE	NULL
LAST_CHGD_BY	NUMBER(10,0)	NOT NULL
LAST_CHGD_DT	DATE	NOT NULL

WG_FOLDER (405)

FOLDER_ID (PK)	NUMBER(10,0)	NOT NULL
BUS_ORG_ID (FK)	NUMBER(10,0)	NULL
FOLDER_LABEL	VARCHAR2(40)	NOT NULL
CNTY_CASE_NUM	VARCHAR2(10)	NULL
FOLDER_STAT_CD	CHAR(1)	NOT NULL
START_DT	DATE	NOT NULL
END_DT	DATE	NULL
FOLDER_DESC	VARCHAR2(25)	NULL
LAST_CHGD_BY	NUMBER(10,0)	NOT NULL
LAST_CHGD_DT	DATE	NOT NULL

DEX_DATASTORE (3500)

DEX_ID (PK)	NUMBER(10,0)	NOT NULL
DEX_FILE_KIND_CD	VARCHAR2(3)	NULL
DEX_NAME	VARCHAR2(128)	NULL
DEX_CONTENTS	CLOB	NULL
DEX_FILE_STATUS_CD	VARCHAR2(2)	NULL
DEX_FILE_DT	DATE	NULL

AUTHORIZED_SERVICE (1105)

AUTH_SERVICE_ID (PK)	NUMBER(10,0)	NOT NULL
AUTH_ID (FK)	NUMBER(10,0)	NOT NULL
PERSON_ID (FK)	NUMBER(10,0)	NOT NULL
SUBPROG_ID (FK)	NUMBER(10,0)	NOT NULL
BRASS_SVC_ID (FK)	NUMBER(10,0)	NOT NULL
CNTY_SUBSVC_ID (FK)	NUMBER(10,0)	NULL
SUBSTITUTE_PROV_ID	NUMBER(10,0)	NULL
SVC_AMT_USED	NUMBER(10,2)	NULL
UNITS_AUTH	NUMBER(10,2)	NOT NULL
FUNDING_SRCE_CD	CHAR(4)	NULL
FUNDING_SRCE_2_CD	CHAR(4)	NULL
FUNDING_SRCE_3_CD	CHAR(4)	NULL
UNIT_TYPE_CD	VARCHAR2(2)	NOT NULL
START_DT	DATE	NOT NULL
END_DT	DATE	NULL
HCPCS_CD	VARCHAR2(5)	NULL
COFARS_OBJ_CD	CHAR(4)	NULL
UNIT_RATE	NUMBER(10,4)	NOT NULL
AUTH_DESCRIPTION	VARCHAR2(200)	NULL
P_O_NUM	VARCHAR2(20)	NULL
TOTAL_POINTS	NUMBER(10,0)	NULL
CLOTHING_ALLOW_AMT	NUMBER(10,2)	NULL
LAST_CHGD_BY	NUMBER(10,0)	NOT NULL
LAST_CHGD_DT	DATE	NOT NULL

SERVICE_AUTH (1100)

AUTH_ID (PK)	NUMBER(10,0)	NOT NULL
BUS_ORG_ID (FK)	NUMBER(10,0)	NOT NULL
CONTRACT_ID	NUMBER(10,0)	NULL
AUTH_STAT_CD	CHAR(1)	NOT NULL
AUTH_STAT_DT	DATE	NOT NULL
AUTH_BY_ID (FK)	NUMBER(10,0)	NULL
WG_ID (FK)	NUMBER(10,0)	NULL
PERS_REL_PROV_IND	CHAR(1)	NULL
CNTY_AUTH_NUM	VARCHAR2(10)	NULL
AGREEMENT_NUM	VARCHAR2(13)	NOT NULL
LAST_CHGD_BY	NUMBER(10,0)	NOT NULL
LAST_CHGD_DT	DATE	NOT NULL

GTTBL_TI_ANSWER

TI_ANSWER_ID	NUMBER(10,0)	NOT NULL
DT_QUESTION_ID	NUMBER(10,0)	NOT NULL
DT_ANSWER_ID	NUMBER(10,0)	NOT NULL
TI_PERSON_ID	NUMBER(10,0)	NULL
TI_TOOL_ID	NUMBER(10,0)	NOT NULL
TI_ANSWER_SCORE	NUMBER(3,0)	NULL
TI_ANSWER_TEXT	VARCHAR2(1024)	NULL
EXCL_FROM_SCORE_IND	VARCHAR2(1)	NOT NULL
PRIORITY_IND	CHAR(1)	NULL

GTTBL_TI_PERSON

TI_PERSON_ID	NUMBER(10,0)	NOT NULL
TI_TOOL_ID	NUMBER(10,0)	NOT NULL
PERSON_ID	NUMBER(10,0)	NOT NULL
PERSON_DT_ROLE_CD	VARCHAR2(6)	NOT NULL

GTTBL_TI_TOOL

TI_TOOL_ID	NUMBER(10,0)	NOT NULL
DT_TOOL_TEMPLATE_ID	NUMBER(10,0)	NOT NULL
WG_ID	NUMBER(10,0)	NULL
STAFF_ID	NUMBER(10,0)	NULL
APPROVE_STAFF_ID	NUMBER(10,0)	NULL
TOOL_CREATE_DT	DATE	NULL
TOOL_ASSESSMENT_DT	DATE	NULL
TOOL_FINALIZE_DT	DATE	NULL
TOOL_STATUS_CD	VARCHAR2(2)	NULL

GTTBL_TI_DECISION

TI_DECISION_ID	NUMBER(10,0)	NOT NULL
TI_TOOL_ID	NUMBER(10,0)	NOT NULL
TI_PERSON_ID	NUMBER(10,0)	NULL
DT_DECISION_TREE_ID	NUMBER(10,0)	NULL
CALCULATED_SCORE	NUMBER(5,0)	NULL
DECISION_CD	VARCHAR2(6)	NULL
OVERRIDE_CD	VARCHAR2(6)	NULL

SPECIAL_NEEDS (585)

SPECIAL_NEEDS_ID (PK)	NUMBER(10,0)	NOT NULL
PERSON_ID (FK)	NUMBER(10,0)	NOT NULL
SPECIAL_NEED_CD	CHAR(2)	NOT NULL
PRIMARY_SN_IND	VARCHAR2(1)	NULL
LAST_CHGD_BY	NUMBER(10,0)	NOT NULL
LAST_CHGD_DT	DATE	NOT NULL

PERSON_TPR (2965)

PERSON_TPR_ID (PK)	NUMBER(10,0)	NOT NULL
PERSON_ID (FK)	NUMBER(10,0)	NOT NULL
PERSON_ID_2 (FK)	NUMBER(10,0)	NOT NULL
RELATION_ID (FK)	NUMBER(10,0)	NOT NULL
TPR_TYPE_CD	VARCHAR2(1)	NULL
TERM_DT	DATE	NULL
TERM_REASON_CD	VARCHAR2(1)	NULL
LAST_CHGD_BY	NUMBER(10,0)	NOT NULL
LAST_CHGD_DT	DATE	NOT NULL

TI_PERSON (5315)

TI_PERSON_ID (PK)	NUMBER(10,0)	NOT NULL
TI_TOOL_ID (FK)	NUMBER(10,0)	NOT NULL
PERSON_ID	NUMBER(10,0)	NOT NULL
PERSON_DT_ROLE_CD	VARCHAR2(6)	NOT NULL
LAST_CHGD_BY	NUMBER(10,0)	NOT NULL
LAST_CHGD_DT	DATE	NOT NULL

DT_SQL (5290)

DT_SQL_ID (PK)	NUMBER(10,0)	NOT NULL
SQL_DESCRIPTION	VARCHAR2(128)	NOT NULL
SQL_TO_RUN	CLOB	NOT NULL
LAST_CHGD_BY	NUMBER(10,0)	NOT NULL
LAST_CHGD_DT	DATE	NOT NULL

DT_TOOL_WG_RULES (5295)

DT_TOOL_WG_RULES_ID (PK)	NUMBER(10,0)	NOT NULL
DT_TOOL_TEMPLATE_ID (FK)	NUMBER(10,0)	NOT NULL
WG_TYPE_CD	CHAR(1)	NULL
SUBPROG_ID	NUMBER(10,0)	NOT NULL
TRACK_CD	VARCHAR2(1)	NULL
LAST_CHGD_BY	NUMBER(10,0)	NOT NULL
LAST_CHGD_DT	DATE	NOT NULL

DT_XML_DATA (5330)

DT_XML_DATA_ID (PK)	NUMBER(10,0)	NOT NULL
XML_1	CLOB	NULL
TBL_1	VARCHAR2(32)	NULL
XML_2	CLOB	NULL
TBL_2	VARCHAR2(32)	NULL
XML_3	CLOB	NULL
TBL_3	VARCHAR2(32)	NULL
XML_4	CLOB	NULL
TBL_4	VARCHAR2(32)	NULL

DOC_ASSESS (2945)

DOC_ASSESS_ID (PK)	NUMBER(10,0)	NOT NULL
PERSON_ID (FK)	NUMBER(10,0)	NOT NULL
STAFF_ID (FK)	NUMBER(10,0)	NOT NULL
DOC_ASSESS_DT	DATE	NULL
DOC_EFF_DT	DATE	NULL
DOC_POINTS	NUMBER(10,0)	NULL
DOC_DESC	VARCHAR2(600)	NULL
DOC_LEVEL_CD	VARCHAR2(1)	NULL
LAST_CHGD_BY	NUMBER(10,0)	NOT NULL
LAST_CHGD_DT	DATE	NOT NULL

RELATION (695)

RELATION_ID (PK)	NUMBER(10,0)	NOT NULL
RELATION_DESC	VARCHAR2(100)	NOT NULL
PERSON1_NEU_DESC	VARCHAR2(50)	NOT NULL
PERSON1_MAS_DESC	VARCHAR2(50)	NOT NULL
PERSON1_FEM_DESC	VARCHAR2(50)	NOT NULL
PERSON2_NEU_DESC	VARCHAR2(50)	NOT NULL
PERSON2_MAS_DESC	VARCHAR2(50)	NOT NULL
PERSON2_FEM_DESC	VARCHAR2(50)	NOT NULL
MALT_VIEW_IND	CHAR(1)	NULL
PLCMT_VIEW_IND	VARCHAR2(1)	NULL
LAST_CHGD_BY	NUMBER(10,0)	NOT NULL
LAST_CHGD_DT	DATE	NOT NULL

(5,3)

OTHER_IDS (540)

OTHER_IDS_ID (PK)	NUMBER(10,0)	NOT NULL
PERSON_ID (FK)	NUMBER(10,0)	NOT NULL
OTHER_ID	VARCHAR2(20)	NOT NULL
OTHER_ID_TYPE_CD	CHAR(1)	NOT NULL
EFF_START_DT	DATE	NOT NULL
LAST_CHGD_BY	NUMBER(10,0)	NOT NULL
LAST_CHGD_DT	DATE	NOT NULL

FIELD_OF_PRACTICE (2330)

FIELD_PRACTICE_ID (PK)	NUMBER(10,0)	NOT NULL
FIELD_PRACTICE	VARCHAR2(80)	NULL
USER_GEN_IND	CHAR(1)	NULL
LAST_CHGD_BY	NUMBER(10,0)	NOT NULL
LAST_CHGD_DT	DATE	NOT NULL

DISABILITY (535)

DISABILITY_ID (PK)	NUMBER(10,0)	NOT NULL
PERSON_ID (FK)	NUMBER(10,0)	NULL
HIGHLVL_DISABIL_CD	CHAR(2)	NULL
START_DT	DATE	NULL
END_DT	DATE	NULL
SEVERITY_CD	CHAR(1)	NULL
CORRECTABLE_IND	CHAR(1)	NULL
THERAPY_REQ_IND	CHAR(1)	NULL
LAST_CHGD_BY	NUMBER(10,0)	NOT NULL
LAST_CHGD_DT	DATE	NOT NULL

LICENSEE_TRAINING (660)

LICENSEE_TRAIN_ID (PK)	NUMBER(10,0)	NOT NULL
PERSON_ID (FK)	NUMBER(10,0)	NULL
TRAIN_DT	DATE	NULL
COURSE_NAME	VARCHAR2(50)	NULL
COURSE_REQ_IND	CHAR(1)	NULL
HOURS	NUMBER(10,2)	NULL
SPONSORED_BY	VARCHAR2(40)	NULL
PRESENTED_BY	VARCHAR2(40)	NULL
LAST_CHGD_BY	NUMBER(10,0)	NOT NULL
LAST_CHGD_DT	DATE	NOT NULL

PERSON_ILS (595)

PERSON_ILS_ID (PK)	NUMBER(10,0)	NOT NULL
PERSON_ID (FK)	NUMBER(10,0)	NOT NULL
REPORTING_YEAR	NUMBER(10,0)	NOT NULL
SELF_AGENCY_CD	CHAR(2)	NULL
OTHER	VARCHAR2(30)	NULL
PARENT_IND	CHAR(1)	NOT NULL
NUM_OF_CHILDREN	NUMBER(10,0)	NULL
MARRIED_IND	CHAR(1)	NOT NULL
SELF_LIV_ARRGMT_CD	CHAR(1)	NULL
SELF_EDUC_CD	CHAR(1)	NULL
TIME_CARE_CD	CHAR(1)	NULL
SELF_HIGHEST_GRADE	NUMBER(10,0)	NULL
NO_SELF_FUNDED_IND	CHAR(1)	NULL
COURT_PLCMT_IND	CHAR(1)	NULL
STATE_WARD_IND	CHAR(1)	NULL
PLCMT_IND	CHAR(1)	NULL
LAST_CHGD_BY	NUMBER(10,0)	NOT NULL
LAST_CHGD_DT	DATE	NOT NULL

NAME (505)

NAME_ID (PK)	NUMBER(10,0)	NOT NULL
PERSON_ID (FK)	NUMBER(10,0)	NOT NULL
TITLE_OF_COURTESY	VARCHAR2(6)	NULL
LAST_NAME	VARCHAR2(30)	NOT NULL
FIRST_NAME	VARCHAR2(20)	NOT NULL
MIDDLE_NAME	VARCHAR2(20)	NULL
NAME_SUFFIX	VARCHAR2(5)	NULL
NAME_TYPE_CD	CHAR(1)	NOT NULL
SOUNDEX_LAST	VARCHAR2(6)	NOT NULL
SOUNDEX_FIRST	VARCHAR2(6)	NOT NULL
UPPER_LAST	VARCHAR2(30)	NULL
UPPER_FIRST	VARCHAR2(20)	NULL
LAST_CHGD_BY	NUMBER(10,0)	NOT NULL
LAST_CHGD_DT	DATE	NOT NULL

PERSON_ADDRESS_XREF (510)

PERSON_ADD_XREF_ID (PK)	NUMBER(10,0)	NOT NULL
PERSON_ID (FK)	NUMBER(10,0)	NOT NULL
ADDRESS_ID (FK)	NUMBER(10,0)	NOT NULL
ADDR_TYPE_CD	CHAR(1)	NOT NULL
START_DT	DATE	NOT NULL
END_DT	DATE	NULL
NO_MAIL_IND	CHAR(1)	NULL
EXCEPTION_ADDR_CD	CHAR(1)	NULL
CARE_OF_LINE	VARCHAR2(40)	NULL
LAST_CHGD_BY	NUMBER(10,0)	NOT NULL
LAST_CHGD_DT	DATE	NOT NULL

ADDRESS (2320)

ADDRESS_ID (PK)	NUMBER(10,0)	NOT NULL
CNTY_CD	CHAR(2)	NULL
ADDR_1	VARCHAR2(100)	NULL
ADDR_2	VARCHAR2(100)	NULL
ADDR_3	VARCHAR2(100)	NULL
CITY	VARCHAR2(25)	NOT NULL
STATE_CD	CHAR(2)	NULL
ZIP_CODE	CHAR(5)	NULL
ZIP_CODE_EXT	VARCHAR2(4)	NULL
COUNTRY	VARCHAR2(30)	NULL
FOREIGN_POST_CODE	VARCHAR2(20)	NULL
DIRECTIONS	VARCHAR2(300)	NULL
UPPER_CITY	VARCHAR2(25)	NULL
FOREIGN_STATE_PROV	VARCHAR2(20)	NULL
CONCAT_ADDR	VARCHAR2(300)	NULL
LAST_CHGD_BY	NUMBER(10,0)	NOT NULL
LAST_CHGD_DT	DATE	NOT NULL

PERSON_DIAGNOSIS(537)

PERSON_DIAG_ID (PK)	NUMBER(10,0)	NOT NULL
PERSON_ID (FK)	NUMBER(10,0)	NOT NULL
DIAGNOSIS_ID (FK)	NUMBER(10,0)	NOT NULL
DIAG_START_DT	DATE	NULL
DIAG_END_DT	DATE	NULL
PRIMARY_DIAG_IND	VARCHAR2(1)	NULL
LAST_CHGD_BY	NUMBER(10,0)	NOT NULL
LAST_CHGD_DT	DATE	NOT NULL

OUTCOME_IND_RESULTS (2400)

QUERY_ID	NUMBER(10,0)	NOT NULL
FLAG	CHAR(1)	NULL
PERSON_ID (FK)	NUMBER(10,0)	NULL
WG_ID (FK)	NUMBER(10,0)	NULL
CONTPLCMT_ID (FK)	NUMBER(10,0)	NULL
CONTPLCMT_START_DT	DATE	NULL
CONTPLCMT_END_DT	DATE	NULL
LOC_START_DT	DATE	NULL
PLCMT_LOC_ID (FK)	NUMBER(10,0)	NULL
LOC_SETTING_CD	VARCHAR2(2)	NULL
CP_RPT_ID (FK)	NUMBER(10,0)	NULL
TERM_DT	DATE	NULL
ALLEG_DETERM_DT	DATE	NULL
CP_RPT_END_DT	DATE	NULL
CP_SVCS_NEED_IND	VARCHAR2(1)	NULL
MALT_TYPES	VARCHAR2(60)	NULL
MONTHS_IN_CARE	NUMBER(10,0)	NULL
INFO	VARCHAR2(60)	NULL
BUCKET	NUMBER(10,0)	NULL

PREV_RMV_ADOPT (2950)

PREV_RMV_ADOPT_ID (PK)	NUMBER(10,0)	NOT NULL
PERSON_ID (FK)	NUMBER(10,0)	NOT NULL
FIRST_REMOVED_DT	DATE	NULL
PREV_ADOPT_CD	VARCHAR2(1)	NULL
MOST_RCNT_ADOPT_AGE	NUMBER(3,0)	NULL
ADOPT_FROM_CD	VARCHAR2(1)	NULL
DIS_FRGN_ADOPT_IND	VARCHAR2(1)	NULL
PLACE_AGENCY_DESC	VARCHAR2(255)	NULL
DISRUPT_RSN_DESC	CLOB	NULL
CURR_PLAN_DESC	CLOB	NULL
LAST_CHGD_BY	NUMBER(10,0)	NOT NULL
LAST_CHGD_DT	DATE	NOT NULL

DI_AD_SBM (2515)

DI_AD_SBM_ID (PK)	NUMBER(10,0)	NOT NULL
ADOPTION_ID (FK)	NUMBER(10,0)	NULL
REPORT_ID (FK)	NUMBER(10,0)	NULL
SUBMIT_DT	DATE	NULL
ADOPT_SUBMIT_CD	VARCHAR2(1)	NULL
LAST_CHGD_BY	NUMBER(10,0)	NOT NULL
LAST_CHGD_DT	DATE	NOT NULL

SW_CONTPLCMT (2985)

SW_CONTPLCMT_ID (PK)	NUMBER(10,0)	NOT NULL
SW_INDEX_ID	NUMBER(10,0)	NOT NULL
CONTPLCMT_ID (FK)	NUMBER(10,0)	NOT NULL
CONTPLCMT_START_DT	DATE	NOT NULL
CONTPLCMT_END_DT	DATE	NULL
FROM_CNTY_CD	VARCHAR2(2)	NOT NULL
LAST_CHGD_BY	NUMBER(10,0)	NOT NULL
LAST_CHGD_DT	DATE	NOT NULL

IVE_ABSTRACT_RCOV (5110)

IVE_ABSTRACT_RCOV_ID (PK)	NUMBER(10,0)	NOT NULL
STATE_RPT_ID (FK)	NUMBER(10,0)	NOT NULL
RECOVERY_AMT	NUMBER(10,0)	NOT NULL
LAST_CHGD_BY	NUMBER(10,0)	NOT NULL
LAST_CHGD_DT	DATE	NOT NULL

CHECKUP (2960)

CHECKUP_ID (PK)	NUMBER(10,0)	NOT NULL
PERSON_ID (FK)	NUMBER(10,0)	NOT NULL
CHECKUP_PROV_DT	DATE	NULL
CHECKUP_TYPE_CD	VARCHAR2(1)	NULL
LAST_CHGD_BY	NUMBER(10,0)	NOT NULL
LAST_CHGD_DT	DATE	NOT NULL

GUARDIANSHIP (2955)

GUARDIANSHIP_ID (PK)	NUMBER(10,0)	NOT NULL
PERSON_ID (FK)	NUMBER(10,0)	NOT NULL
GUARDIANSHIP_TYPE_CD	VARCHAR2(2)	NULL
GUARDIANSHIP_EFF_DT	DATE	NULL
LAST_CHGD_BY	NUMBER(10,0)	NOT NULL
LAST_CHGD_DT	DATE	NOT NULL

ADOPTION (415)

ADOPTION_ID (PK)	NUMBER(10,0)	NOT NULL
WG_ID (FK)	NUMBER(10,0)	NULL
PERSON_ID (FK)	NUMBER(10,0)	NOT NULL
STRUCT_AD_FAM_CD	CHAR(1)	NULL
ADOPT_STATUS_CD	CHAR(1)	NULL
FOSTERPRNT1_REL_CD	CHAR(1)	NULL
FOSTERPRNT2_REL_CD	CHAR(1)	NULL
CNTY_COMMITMENT_CD	CHAR(2)	NULL
SUPERVIS_AGENCY_CD	CHAR(3)	NULL
RESP_AGENCY_CD	CHAR(3)	NULL
OTHER_CONTACT_NAME	VARCHAR2(40)	NULL
OTHER_PHONE	VARCHAR2(14)	NULL
RESP_AGENCY_PHN	VARCHAR2(14)	NULL
RESP_AGENCY_WKR	VARCHAR2(40)	NULL
RESP_AGENCY_SUP	VARCHAR2(40)	NULL
RESP_AGENCY_SUPPHN	VARCHAR2(14)	NULL
OTHER_AGCY_ROLE_CD	CHAR(1)	NULL
PRNT1_MSTAT_REL_CD	CHAR(1)	NULL
PRNT2_MSTAT_REL_CD	CHAR(1)	NULL
PRNT1_MSTAT_BTH_CD	CHAR(1)	NULL
PRNT2_MSTAT_BTH_CD	CHAR(1)	NULL
OTHER_AGENCY_CD	CHAR(3)	NULL
ADOPTPET_RPT_DT	DATE	NULL
SAE_RPT_DT	DATE	NULL
STATEWARD_RPT_DT	DATE	NULL
RSP_AGCY_WKR_EMAIL	VARCHAR2(100)	NULL
PRNT_1_ID (FK)	NUMBER(10,0)	NULL
PRNT_2_ID (FK)	NUMBER(10,0)	NULL
TERM_COMPLETE_1_IND	VARCHAR2(1)	NULL
TERM_COMPLETE_2_IND	VARCHAR2(1)	NULL
TERM_PROG_DT_1_CD	VARCHAR2(1)	NULL
TERM_PROG_DT_2_CD	VARCHAR2(1)	NULL
ALLEG_FATHER_IND	VARCHAR2(1)	NULL
TERM_PROG_1_DT	DATE	NULL
TERM_PROG_2_DT	DATE	NULL
CONTPLCMT_ID (FK)	NUMBER(10,0)	NULL
STATE_INVOLV_IND	VARCHAR2(1)	NULL
CHILD_PLC_FROM_CD	VARCHAR2(1)	NULL
CHILD_PLC_TO_CD	VARCHAR2(1)	NULL
MONTHLY_AA_MAINT_IND	VARCHAR2(1)	NULL
MONTHLY_AA_AMOUNT	NUMBER(10,0)	NULL
MONTHLY_AA_IVE_IND	VARCHAR2(1)	NULL
LAST_CHGD_BY	NUMBER(10,0)	NOT NULL
LAST_CHGD_DT	DATE	NOT NULL

SPD_PLACEMENT (2025)

SPD_PLACEMENT_ID (PK)	NUMBER(10,0)	NOT NULL
PLCMT_LOC_ID (FK)	NUMBER(10,0)	NOT NULL
SVC_PLAN_DOC_ID (FK)	NUMBER(10,0)	NOT NULL
LAST_CHGD_BY	NUMBER(10,0)	NOT NULL
LAST_CHGD_DT	DATE	NOT NULL

PERSON_WARD_PLCMT (689)

PERSON_WARD_PLCMT_ID (PK)	NUMBER(10,0)	NOT NULL
PERSON_WARD_ID (FK)	NUMBER(10,0)	NOT NULL
AD_WARD_EVENT_ID	NUMBER(10,0)	NULL
PLCMT_LOC_ID (FK)	NUMBER(10,0)	NOT NULL
LAST_CHGD_BY	NUMBER(10,0)	NOT NULL
LAST_CHGD_DT	DATE	NOT NULL

PERSON_WARD (687)

PERSON_WARD_ID (PK)	NUMBER(10,0)	NOT NULL
PERSON_ID (FK)	NUMBER(10,0)	NULL
WG_ID (FK)	NUMBER(10,0)	NULL
AD_WARD_ID	NUMBER(10,0)	NULL
COUNTY_ACTIVE_IND	VARCHAR2(1)	NULL
LAST_CHGD_BY	NUMBER(10,0)	NOT NULL
LAST_CHGD_DT	DATE	NOT NULL

PERSON_WARD_REL (691)

PERSON_WARD_REL_ID (PK)	NUMBER(10,0)	NOT NULL
PERSON_WARD_ID (FK)	NUMBER(10,0)	NOT NULL
RELATIONSHIP_ID (FK)	NUMBER(10,0)	NOT NULL
AD_WARD_EVENT_ID	NUMBER(10,0)	NOT NULL
AD_WARD_RELATE_ID	NUMBER(10,0)	NULL
LAST_CHGD_BY	NUMBER(10,0)	NOT NULL
LAST_CHGD_DT	DATE	NOT NULL

CLM_ELEMENT (4565)

CLM_ELEMENT_ID (PK)	NUMBER(10,0)	NOT NULL
CLAIM_CAT_CD	VARCHAR2(1)	NOT NULL
CLM_ELEMENT_TYPE	VARCHAR2(15)	NOT NULL
CLM_ELEMENT_NAME	VARCHAR2(30)	NOT NULL
CLM_ELEMENT_START_DT	DATE	NULL
CLM_ELEMENT_END_DT	DATE	NULL
CLM_ELEMENT_VALUE	VARCHAR2(30)	NULL
LAST_CHGD_BY	NUMBER(10,0)	NOT NULL
LAST_CHGD_DT	DATE	NOT NULL

SVC_PLAN_DOC (2000)

SVC_PLAN_DOC_ID (PK)	NUMBER(10,0)	NOT NULL
WG_ID (FK)	NUMBER(10,0)	NOT NULL
PLAN_TYPE_CD	CHAR(1)	NULL
PLAN_STATUS_CD	CHAR(1)	NULL
PLAN_STATUS_DT	DATE	NULL
PLAN_EFF_FROM_DT	DATE	NULL
PLAN_EFF_TO_DT	DATE	NULL
PLAN_DOC	BLOB	NULL
SSIS_DOCUMENT_ID (FK)	NUMBER(10,0)	NULL
LAST_CHGD_BY	NUMBER(10,0)	NOT NULL
LAST_CHGD_DT	DATE	NOT NULL

SPD_CLIENT (2005)

SPD_CLIENT_ID (PK)	NUMBER(10,0)	NOT NULL
SVC_PLAN_DOC_ID (FK)	NUMBER(10,0)	NOT NULL
PERSON_ID (FK)	NUMBER(10,0)	NOT NULL
LAST_CHGD_BY	NUMBER(10,0)	NOT NULL
LAST_CHGD_DT	DATE	NOT NULL

DI_IVE_RATE (2610)

DI_IVE_RATE_ID (PK)	NUMBER(10,0)	NOT NULL
RATE_GROUP	VARCHAR2(60)	NULL
FACILITY	VARCHAR2(80)	NULL
CNTY_CITY	VARCHAR2(50)	NULL
RULE_NUM	VARCHAR2(3)	NULL
DHS_LIC_NUM	VARCHAR2(10)	NULL
IVE_SUB_CD	VARCHAR2(1)	NULL
APPR_PER_DIEM	NUMBER(6,2)	NULL
APPR_IVE_MTN_PCNT	NUMBER(6,2)	NULL
APPR_IVE_INTK_PCNT	NUMBER(6,2)	NULL
APPR_IVE_TRNG_PCNT	NUMBER(6,2)	NULL
APPR_MA_PCNT	NUMBER(6,2)	NULL
MA_PROVIDER_NUM	VARCHAR2(10)	NULL
EFF_DT	DATE	NULL
EXP_DT	DATE	NULL
EXP_REASON	VARCHAR2(23)	NULL
CUR_CONTRACT_LIC	VARCHAR2(23)	NULL
BLTN_EFF_DT	DATE	NULL
BLTN_EXP_DT	DATE	NULL
LAST_CHGD_BY	NUMBER(10,0)	NOT NULL
LAST_CHGD_DT	DATE	NOT NULL

ELIG_LTC_SCRNG (4560)

ELIG_LTC_SCRNG_ID (PK)	NUMBER(10,0)	NOT NULL
PERSON_ID (FK)	NUMBER(10,0)	NULL
WG_ID (FK)	NUMBER(10,0)	NULL
READY_TO_CLAIM_IND	VARCHAR2(1)	NULL
LTC_SCREENING_DT	DATE	NULL
LAST_CHGD_BY	NUMBER(10,0)	NOT NULL
LAST_CHGD_DT	DATE	NOT NULL

CLM_LTC_SCRNG_XREF (4545)

CLM_LTC_SCRNG_XRF_ID (PK)	NUMBER(10,0)	NOT NULL
CLM_HEALTHCARE_ID (FK)	NUMBER(10,0)	NOT NULL
ELIG_LTC_SCRNG_ID (FK)	NUMBER(10,0)	NOT NULL
LAST_CHGD_BY	NUMBER(10,0)	NOT NULL
LAST_CHGD_DT	DATE	NOT NULL

(5,6)

STATE_RPT (4000)

STATE_RPT_ID (PK)	NUMBER(10,0)	NOT NULL
ST_RPT_TYPE_CD	VARCHAR2(1)	NULL
ST_RPT_YEAR	VARCHAR2(4)	NOT NULL
ST_RPT_PERIOD_CD	VARCHAR2(2)	NOT NULL
ST_RPT_STATUS_CD	VARCHAR2(1)	NULL
ST_RPT_STATUS_DT	DATE	NULL
ST_RPT_GEN_DT	DATE	NULL
ST_RPT_REV_NUM	NUMBER(3,0)	NULL
STAFF_ID (FK)	NUMBER(10,0)	NULL
ST_RPT_CONTACT_NAME	VARCHAR2(65)	NULL
ST_CONTACT_PHONE	VARCHAR2(50)	NULL
LAST_CHGD_BY	NUMBER(10,0)	NOT NULL
LAST_CHGD_DT	DATE	NOT NULL

IVE_RPT_RCOV_LINE (4010)

IVE_RPT_RCOV_LINE_ID (PK)	NUMBER(10,0)	NOT NULL
STATE_RPT_ID (FK)	NUMBER(10,0)	NOT NULL
IVE_RPT_RCOV_LINE_CD	VARCHAR2(2)	NULL
FFH_AMT	NUMBER(10,0)	NULL
RES_RULE_5_AMT	NUMBER(10,0)	NULL
RES_RULE_8_AMT	NUMBER(10,0)	NULL
RES_OTHER_AMT	NUMBER(10,0)	NULL
LAST_CHGD_BY	NUMBER(10,0)	NOT NULL
LAST_CHGD_DT	DATE	NOT NULL

IVE_RPT_CLAIM_MAIN (4005)

IVE_RPT_CLM_MAIN_ID (PK)	NUMBER(10,0)	NOT NULL
STATE_RPT_ID (FK)	NUMBER(10,0)	NOT NULL
PERSON_ID (FK)	NUMBER(10,0)	NOT NULL
PAYMENT_ID (FK)	NUMBER(10,0)	NOT NULL
PLACE_AUTH_CD	VARCHAR2(1)	NOT NULL
FACILITY_TYPE_CD	VARCHAR2(3)	NOT NULL
PYMT_DT	DATE	NOT NULL
PYMT_SVC_START_DT	DATE	NOT NULL
PYMT_SVC_END_DT	DATE	NOT NULL
IVE_SVC_TYPE_CD	VARCHAR2(2)	NOT NULL
WG_ID (FK)	NUMBER(10,0)	NULL
PROV_LIC_NUM	VARCHAR2(10)	NOT NULL
IVE_SUB_CD	VARCHAR2(1)	NULL
BUS_ORG_ID (FK)	NUMBER(10,0)	NULL
SVC_BUS_NAME	VARCHAR2(50)	NULL
STUDENT_STAT_CD	CHAR(1)	NULL
CONTPLCMT_START_DT	DATE	NULL
LOC_START_DT	DATE	NULL
VOL_PLCMT_AGRMT_DT	DATE	NULL
BRASS_SVC_ID (FK)	NUMBER(10,0)	NULL
SPECIAL_COST_ID (FK)	NUMBER(10,0)	NULL
BEST_INTEREST_DT	DATE	NULL
SUP_AGCY_CD	VARCHAR2(1)	NULL
PYMT_PAID_AMT	NUMBER(12,2)	NOT NULL
ADJ_PYMT_PAID_AMT	NUMBER(12,2)	NOT NULL
NONREIMB_AMT	NUMBER(12,2)	NULL
PAYING_CNTY_CD	CHAR(2)	NULL
GRAD_BY_19_IND	VARCHAR2(1)	NULL
LAST_CHGD_BY	NUMBER(10,0)	NOT NULL
LAST_CHGD_DT	DATE	NOT NULL

IVE_RPT_CNT_LINE (4015)

IVE_RPT_CNT_LINE_ID (PK)	NUMBER(10,0)	NOT NULL
STATE_RPT_ID (FK)	NUMBER(10,0)	NOT NULL
ADJ_QTR_END_DT	DATE	NULL
IVE_RPT_CNT_LINE_CD	VARCHAR2(2)	NULL
MONTH_1_CNT	NUMBER(10,0)	NULL
MONTH_2_CNT	NUMBER(10,0)	NULL
MONTH_3_CNT	NUMBER(10,0)	NULL
LAST_CHGD_BY	NUMBER(10,0)	NOT NULL
LAST_CHGD_DT	DATE	NOT NULL

IVE_RPT_NON_REMB (4045)

IVE_RPT_NON_REMB_ID (PK)	NUMBER(10,0)	NOT NULL
IVE_RPT_CLM_MAIN_ID (FK)	NUMBER(10,0)	NOT NULL
IVE_NON_REIMB_CD	VARCHAR2(2)	NOT NULL
LAST_CHGD_BY	NUMBER(10,0)	NOT NULL
LAST_CHGD_DT	DATE	NOT NULL

IVE_RPT_PYMT_XREF (4020)

IVE_RPT_PYMT_XREF_ID (PK)	NUMBER(10,0)	NOT NULL
STATE_RPT_ID (FK)	NUMBER(10,0)	NOT NULL
PAYMENT_ID (FK)	NUMBER(10,0)	NOT NULL
IVE_RPT_CLM_MAIN_ID (FK)	NUMBER(10,0)	NOT NULL
IVE_RPT_PROC_CD	VARCHAR2(1)	NOT NULL
LAST_CHGD_BY	NUMBER(10,0)	NOT NULL
LAST_CHGD_DT	DATE	NOT NULL

IVE_RPT_CLAIM_GFA (4035)

IVE_RPT_CLAIM_GFA_ID (PK)	NUMBER(10,0)	NOT NULL
IVE_RPT_CLM_MAIN_ID (FK)	NUMBER(10,0)	NOT NULL
STATE_RPT_ID (FK)	NUMBER(10,0)	NOT NULL
GFA_PER_DIEM	NUMBER(10,2)	NULL
MAINT_PCT	NUMBER(10,2)	NULL
INTK_PLAN_PCT	NUMBER(10,2)	NULL
EXP_UNIT_RATE	NUMBER(10,2)	NULL
LAST_CHGD_BY	NUMBER(10,0)	NOT NULL
LAST_CHGD_DT	DATE	NOT NULL

IVE_RPT_PERSON (4025)

IVE_RPT_PERSON_ID (PK)	NUMBER(10,0)	NOT NULL
STATE_RPT_ID (FK)	NUMBER(10,0)	NOT NULL
PMI	VARCHAR2(10)	NULL
PERSON_ID (FK)	NUMBER(10,0)	NOT NULL
FIRST_NAME	VARCHAR2(20)	NOT NULL
MIDDLE_NAME	VARCHAR2(20)	NULL
LAST_NAME	VARCHAR2(30)	NOT NULL
NAME_SUFFIX	VARCHAR2(5)	NULL
BIRTH_DT	DATE	NULL
LAST_CHGD_BY	NUMBER(10,0)	NOT NULL
LAST_CHGD_DT	DATE	NOT NULL

(5,7)

AP_ALLEG (4705)

AP_ALLEG_ID (PK)	NUMBER(10,0)	NOT NULL
AP_RPT_ID (FK)	NUMBER(10,0)	NOT NULL
OFFENDER_ID (FK)	NUMBER(10,0)	NULL
ALLEG_DETERM_CD	VARCHAR2(2)	NULL
ALLEG_DETERM_DT	DATE	NULL
AP_ALLEGATION_CD	VARCHAR2(2)	NULL
APPEAL_DETERM_CD	VARCHAR2(2)	NULL
PREV_MALT_CD	VARCHAR2(2)	NULL
OFF_MORE_INFO	VARCHAR2(120)	NULL
OFF_NATURE	VARCHAR2(120)	NULL
FIDUCIARY_REL_CD	VARCHAR2(2)	NULL
PERPETRATOR_DESC	VARCHAR2(65)	NULL
LAST_CHGD_BY	NUMBER(10,0)	NOT NULL
LAST_CHGD_DT	DATE	NOT NULL

AP_ALLEG_APEAL (4710)

AP_ALLEG_APEAL_ID (PK)	NUMBER(10,0)	NOT NULL
AP_ALLEG_ID (FK)	NUMBER(10,0)	NOT NULL
AP_APEAL_VENUE_CD	VARCHAR2(2)	NULL
DECISION_DT	DATE	NULL
ALLEG_DETERM_CD	VARCHAR2(2)	NOT NULL
LAST_CHGD_BY	NUMBER(10,0)	NOT NULL
LAST_CHGD_DT	DATE	NOT NULL

AP_RPT_DISABILITY (4725)

AP_RPT_DISABILITY_ID (PK)	NUMBER(10,0)	NOT NULL
AP_RPT_ID (FK)	NUMBER(10,0)	NOT NULL
VA_DISABILITY_CD	VARCHAR2(2)	NOT NULL
LAST_CHGD_BY	NUMBER(10,0)	NOT NULL
LAST_CHGD_DT	DATE	NOT NULL

AP_REFERRAL (4715)

AP_REFERRAL_ID (PK)	NUMBER(10,0)	NOT NULL
AP_RPT_ID (FK)	NUMBER(10,0)	NOT NULL
BUS_ORG_ID (FK)	NUMBER(10,0)	NULL
PERSON_ID (FK)	NUMBER(10,0)	NULL
STAFF_ID (FK)	NUMBER(10,0)	NULL
AP_IND	VARCHAR2(1)	NULL
AP_CNTY_CD	VARCHAR2(2)	NULL
AP_DT	DATE	NULL
AP_CONTACT_NAME	VARCHAR2(65)	NULL
AP_CONTACT_PHONE	VARCHAR2(50)	NULL
LEAD_AGENCY_IND	VARCHAR2(1)	NULL
LEAD_AGENCY_DT	DATE	NULL
LEAD_AGENCY_CNTY_CD	VARCHAR2(2)	NULL
LEAD_AGENCY_STATE_CD	VARCHAR2(2)	NULL
CRIMINAL_ACT_IND	VARCHAR2(1)	NULL
VA_CRIME_CD	VARCHAR2(2)	NULL
POLICE_REPORT_CD	VARCHAR2(2)	NULL
POLICE_REPORT_NUM	VARCHAR2(20)	NULL
CEP_TO_LAW_IND	VARCHAR2(1)	NULL
CEP_TO_LAW_DT	DATE	NULL
LAW_AGENCY_CNTY_CD	VARCHAR2(2)	NULL
LEAD_AGENCY_CD	VARCHAR2(2)	NULL
VA_CRIME_OTHER	VARCHAR2(150)	NULL
OUT_ST_LAW_AGCY_NAME	VARCHAR2(200)	NULL
OUT_ST_LAW_AGCY_CONT	VARCHAR2(120)	NULL
OUT_ST_LAW_AGCY_PHON	VARCHAR2(50)	NULL
LAST_CHGD_BY	NUMBER(10,0)	NOT NULL
LAST_CHGD_DT	DATE	NOT NULL

AP_RPT (4700)

AP_RPT_ID (PK)	NUMBER(10,0)	NOT NULL
WG_ID (FK)	NUMBER(10,0)	NOT NULL
CALLER_PERSON_ID (FK)	NUMBER(10,0)	NULL
RECEIVED_STAFF_ID (FK)	NUMBER(10,0)	NULL
VICTIM_ID (FK)	NUMBER(10,0)	NULL
VA_SPNDX_ID	NUMBER(10,0)	NULL
INCIDENT_SPNDX_ID	NUMBER(10,0)	NULL
VA_BUS_ORG_ID (FK)	NUMBER(10,0)	NULL
INCIDENT_BUS_ORG_ID (FK)	NUMBER(10,0)	NULL
IMMINENT_DANGER_IND	VARCHAR2(1)	NULL
AP_RPT_STATUS_CD	VARCHAR2(2)	NULL
MAND_REPORTER_IND	VARCHAR2(1)	NULL
AP_RPT_SOURCE_CD	VARCHAR2(2)	NULL
AP_RPT_END_DT	DATE	NULL
CALLER_PROTECT_IND	VARCHAR2(1)	NULL
INCIDENT_LOCATION	VARCHAR2(65)	NULL
EST_INCIDENT_DT	DATE	NULL
INT_INVESTIGATE_IND	VARCHAR2(1)	NULL
CORRECTIVE_ACTION	VARCHAR2(120)	NULL
INCIDENT_COMMUN_CD	VARCHAR2(2)	NULL
VA_LIVING_SIT_IND	VARCHAR2(1)	NULL
VA_CLASSIFICATION_CD	VARCHAR2(2)	NULL
RECEIVED_BY_PHONE	VARCHAR2(50)	NULL
RECEIVED_BY	VARCHAR2(40)	NULL
VA_DIAGNOSIS	VARCHAR2(120)	NULL
ISSUED_BY_CD	CHAR(1)	NULL
CALLER_DISP_INIT_IND	VARCHAR2(1)	NULL
CALLER_DISP_FIN_IND	VARCHAR2(1)	NULL
INCIDENT_DESCRIPTION	CLOB	NULL
REPORT_COMPLAINT_IND	VARCHAR2(1)	NULL
CALLER_REFUSE_IND	VARCHAR2(1)	NULL
LAST_CHGD_BY	NUMBER(10,0)	NOT NULL
LAST_CHGD_DT	DATE	NOT NULL

AP_RPT_ROLES (4720)

AP_RPT_ROLES_ID (PK)	NUMBER(10,0)	NOT NULL
AP_RPT_ID (FK)	NUMBER(10,0)	NULL
PERSON_ID1 (FK)	NUMBER(10,0)	NULL
PERSON_ID2 (FK)	NUMBER(10,0)	NULL
AP_ROLE_CD	VARCHAR2(2)	NULL
OTHER_AP_ROLE_INFO	VARCHAR2(65)	NULL
LAST_CHGD_BY	NUMBER(10,0)	NOT NULL
LAST_CHGD_DT	DATE	NOT NULL

AP_LEAD_AGENCY (4730)

AP_LEAD_AGENCY_ID (PK)	NUMBER(10,0)	NOT NULL
AP_REFERRAL_ID (FK)	NUMBER(10,0)	NOT NULL
LEAD_AGENCY_CD	VARCHAR2(2)	NOT NULL
LAST_CHGD_BY	NUMBER(10,0)	NOT NULL
LAST_CHGD_DT	DATE	NOT NULL

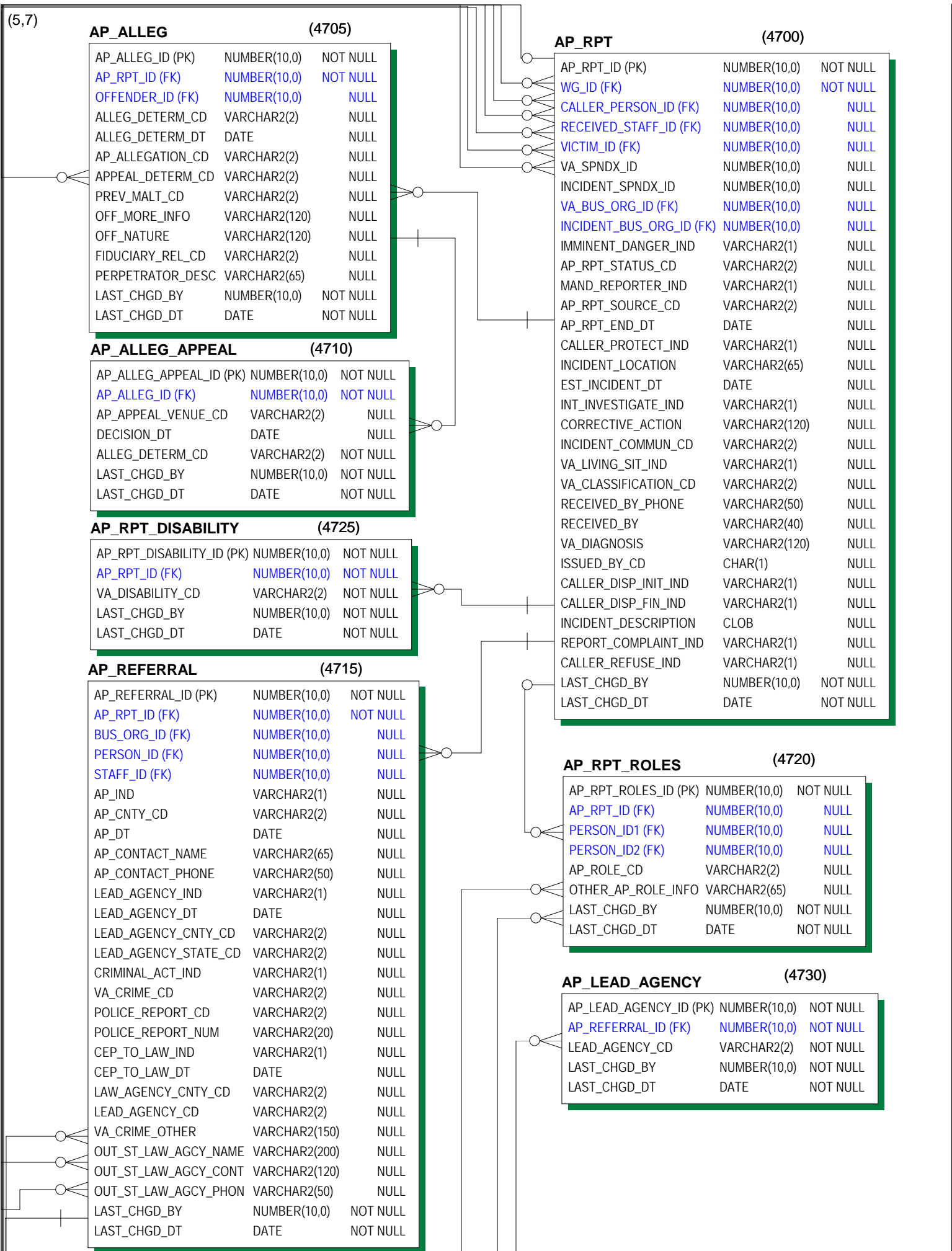

TRANS_DEF (2215)

TRANS_CD (PK)	NUMBER(10,0)	NOT NULL
SUB_CD (PK)	NUMBER(10,0)	NOT NULL
TABLE_OBJ	VARCHAR2(25)	NULL
SEND_IND	CHAR(1)	NULL
SEQ_IND	CHAR(1)	NULL
STATUS	VARCHAR2(40)	NULL
ID_NAME	VARCHAR2(20)	NULL
PARENT_OBJ	VARCHAR2(20)	NULL
RECIEVE_IND	CHAR(1)	NULL

TRANS_TEMPLATE (2205)

TRANS_CD (PK)(FK)	NUMBER(10,0)	NOT NULL
SUB_CD (PK)(FK)	NUMBER(10,0)	NOT NULL
SEQ_NUM (PK)	NUMBER(10,0)	NOT NULL
FLD_ID (FK)	NUMBER(10,0)	NULL
REQ_INS	CHAR(1)	NULL
REQ_UPD_DEL	CHAR(1)	NULL
ALT_DESCRIPTION	VARCHAR2(240)	NULL
LAST_CHGD_DT	DATE	NULL
ACTIVE_IND	CHAR(1)	NULL

DATADICTION (2200)

FLD_ID (PK)	NUMBER(10,0)	NOT NULL
FLD_NAME	VARCHAR2(20)	NULL
FLD_TYPE	CHAR(1)	NULL
FLD_LENGTH	NUMBER(10,0)	NULL
FLD_DEC	NUMBER(10,0)	NULL
NOTE	VARCHAR2(240)	NULL
DESCRIPTION	VARCHAR2(240)	NULL
LAST_CHGD_DT	DATE	NULL
CODE_FLD_NAME	VARCHAR2(18)	NULL
CODE_TBL	VARCHAR2(25)	NULL
CODE_LOOKUP_FLD	VARCHAR2(18)	NULL
LOG_LENGTH	NUMBER(10,0)	NULL

TRANS_LOG2 (2220)

SOURCE_CD (PK)	CHAR(1)	NOT NULL
TRANS_ID (PK)	NUMBER(10,0)	NOT NULL
SEQ_NUM (PK)	NUMBER(10,0)	NOT NULL
CNTY_CD	CHAR(2)	NULL
STAFF_ID	NUMBER(10,0)	NULL
TRANS_DT	DATE	NULL
TRANS_CD	NUMBER(10,0)	NULL
SUB_CD	NUMBER(10,0)	NULL
ACT_CD	CHAR(1)	NULL
ERR_CD	VARCHAR2(40)	NULL
DATA_ID	NUMBER(10,0)	NULL
PROCESSED_IND	CHAR(1)	NULL

TRANS_LOG2_DETAIL (2285)

TRANS_DETAIL_ID (PK)	NUMBER(10,0)	NOT NULL
SOURCE_CD (FK)	CHAR(1)	NULL
TRANS_ID (FK)	NUMBER(10,0)	NULL
SEQ_NUM (FK)	NUMBER(10,0)	NULL
FIELD_SEQ_NUM	NUMBER(10,0)	NULL
FIELD_ID	NUMBER(10,0)	NULL
FIELD_CONTENTS	VARCHAR2(4000)	NULL
NOT_CURRENT_DT	DATE	NULL

CFC_BASIC_PER_DIEM (1490)

DOC_RATE_ID (PK)	NUMBER(10,0)	NOT NULL
YEAR	NUMBER(10,0)	NOT NULL
AGE_LOW	NUMBER(10,0)	NOT NULL
AGE_HIGH	NUMBER(10,0)	NOT NULL
DAILY_BASIC_RATE	NUMBER(10,2)	NOT NULL
CLOTHING_ALLOW_AMT	NUMBER(10,2)	NOT NULL
LAST_CHGD_BY	NUMBER(10,0)	NOT NULL
LAST_CHGD_DT	DATE	NOT NULL

DOC_SCHEDULE (1485)

DOC_SCHEDULE_ID (PK)	NUMBER(10,0)	NOT NULL
YEAR	NUMBER(10,0)	NOT NULL
AGE_HIGH	NUMBER(10,0)	NOT NULL
AGE_LOW	NUMBER(10,0)	NOT NULL
TOTAL_POINTS	NUMBER(10,0)	NOT NULL
DOC_BASIC_PER_DIEM	NUMBER(10,2)	NOT NULL
LAST_CHGD_BY	NUMBER(10,0)	NOT NULL
LAST_CHGD_DT	DATE	NOT NULL

SYSTEM_CONTROL (1465)

CNTY_CD (PK)	CHAR(2)	NOT NULL
ADDR_1	VARCHAR2(100)	NULL
ADDR_2	VARCHAR2(100)	NULL
SYS_CITY	VARCHAR2(25)	NULL
SYS_STATE_CD	CHAR(2)	NULL
SYS_ZIP_CODE	CHAR(5)	NULL
SYS_ZIP_CODE_EXT	VARCHAR2(4)	NULL
TR_PERIOD_CD	CHAR(1)	NULL
WEEKLY_START_DT	DATE	NULL
DIRECTOR_LAST	VARCHAR2(30)	NULL
DIRECTOR_FIRST	VARCHAR2(20)	NULL
NEXT_SEQ_NUM	NUMBER(10,0)	NULL
DB_VERSION	VARCHAR2(8)	NULL
CNTY_IND_1	CHAR(1)	NULL
CNTY_IND_2	CHAR(1)	NULL
HOURS_PER_DAY	NUMBER(5,2)	NULL
PURGE_RUNDAY	NUMBER(2,0)	NOT NULL
TR_LOG_PREV_MONTHS	NUMBER(10,0)	NULL
AGENCY_PHONE	VARCHAR2(50)	NULL
APPEAL_PHONE	VARCHAR2(50)	NULL
DEF_INTK_ACC_REST_CD	CHAR(1)	NULL
INTAKE_UNIT_ID	NUMBER(10,0)	NULL
AGENCY_NAME	VARCHAR2(80)	NULL
BUSORG_SVC_REQ_IND	VARCHAR2(1)	NULL
CNTY_DSH_PROV_NUM	VARCHAR2(9)	NULL
CNTY_EMP_ID_NUM	VARCHAR2(9)	NULL
PYMT_INT_REQOWNR_IND	VARCHAR2(1)	NULL
DB_GUID2	VARCHAR2(32)	NULL
LAST_CHGD_BY	NUMBER(10,0)	NOT NULL
LAST_CHGD_DT	DATE	NOT NULL

VAR_STORAGE (2260)

VAR_ID (PK)	NUMBER(10,0)	NOT NULL
VAR_NAME	VARCHAR2(30)	NULL
VAR_VALUE	VARCHAR2(4000)	NULL

DIAGNOSIS_CODE (1445)

DIAGNOSIS_ID (PK)	NUMBER(10,0)	NOT NULL
DIAGNOSIS_CD	VARCHAR2(6)	NOT NULL
DIAG_TYPE_CD	CHAR(1)	NOT NULL
DIAG_DESC	VARCHAR2(100)	NOT NULL
DIAG_CD_START_DT	DATE	NULL
DIAG_CD_END_DT	DATE	NULL
NONSPECIFIC_IND	VARCHAR2(1)	NULL
LAST_CHGD_BY	NUMBER(10,0)	NOT NULL
LAST_CHGD_DT	DATE	NOT NULL

CODE (1430)

FIELDNAME (PK)	VARCHAR2(20)	NOT NULL
CODE (PK)	VARCHAR2(6)	NOT NULL
DESCRIPTION	VARCHAR2(65)	NOT NULL
SORT_ORDER	NUMBER(10,0)	NULL
ACTIVE_IND	CHAR(1)	NOT NULL
LAST_CHGD_BY	NUMBER(10,0)	NOT NULL
LAST_CHGD_DT	DATE	NOT NULL

SSISVNDR

VIVNO (PK)	VARCHAR2(20)	NOT NULL
VIDELT	VARCHAR2(1)	NULL

IMP_TMPL_HOLD (397)

IMP_TMPL_HOLD_ID (PK)	CHAR(10)	NOT NULL
IMP_TMPL_XML	CLOB	NULL

COURT_DETAIL (1500)

COURT_DETAIL_ID (PK)	NUMBER(10,0)	NOT NULL
PERSON_ID (FK)	NUMBER(10,0)	NULL
COURT_HEARING_DT	DATE	NULL
COURT_TYPE_CD	CHAR(1)	NULL
PETITION_DT	DATE	NULL
PETITION_CD	CHAR(2)	NULL
HEARING_TYPE_CD	CHAR(2)	NULL
BEST_INTEREST_IND	CHAR(1)	NULL
BEST_INTEREST_DT	DATE	NULL
DISPOSITION_DT	DATE	NULL
PETITION_DETAIL_CD	CHAR(1)	NULL
REASONABLE_EFF_CD	CHAR(1)	NULL
REASONABLE_EFF_DT	DATE	NULL
REAS_EFF_PERM_DT	DATE	NULL
REAS_EFF_PERM_IND	CHAR(1)	NULL
CONTPLCMT_ID (FK)	NUMBER(10,0)	NULL
PLCMT_REVIEW_IND	VARCHAR2(1)	NULL
LAST_CHGD_BY	NUMBER(10,0)	NOT NULL
LAST_CHGD_DT	DATE	NOT NULL

COURT_DISPOSITION (1510)

COURT_DISP_ID (PK)	NUMBER(10,0)	NOT NULL
COURT_DETAIL_ID (FK)	NUMBER(10,0)	NOT NULL
DISPOSITION_CD	CHAR(2)	NOT NULL
LAST_CHGD_BY	NUMBER(10,0)	NOT NULL
LAST_CHGD_DT	DATE	NOT NULL

PERSON_SUBSTANCE (698)

PERSON_SUBSTANCE_ID (PK)	NUMBER(10,0)	NOT NULL
PERSON_ID (FK)	NUMBER(10,0)	NOT NULL
STAFF_ID (FK)	NUMBER(10,0)	NULL
SUBSTANCE_CD	VARCHAR2(2)	NULL
INVOLV_CD	VARCHAR2(1)	NULL
SUBS_OF_CHOICE_IND	VARCHAR2(1)	NULL
IDENTIFIED_DT	DATE	NULL
NON_ISSUE_DT	DATE	NULL
PSUBS_COMMENTS	VARCHAR2(256)	NULL
PS_NO_KNOWN_IND	VARCHAR2(1)	NULL
PS_REVIEWED_DT	DATE	NULL
LAST_CHGD_BY	NUMBER(10,0)	NOT NULL
LAST_CHGD_DT	DATE	NOT NULL

PURGE_LOG (2275)

PURGE_LOG_ID (PK)	NUMBER(10,0)	NOT NULL
WG_ID	NUMBER(10,0)	NULL
WG_LABEL	VARCHAR2(80)	NOT NULL
SUBPROG_ID (FK)	NUMBER(10,0)	NULL
START_DT	DATE	NULL
END_DT	DATE	NULL
PURGE_DT	DATE	NULL
CNTY_CASE_NUM	VARCHAR2(10)	NULL
APP_NUM	CHAR(2)	NULL
CNTY_CASE_NUMBER	VARCHAR2(10)	NULL

SCHOOL_DISTRICT (1435)

SCHOOL_DIST_NUM (PK)	CHAR(4)	NOT NULL
SCHOOL_DIST_NAME	VARCHAR2(40)	NOT NULL
EFF_START_DT	DATE	NULL
EFF_END_DT	DATE	NULL
LAST_CHGD_BY	NUMBER(10,0)	NOT NULL
LAST_CHGD_DT	DATE	NOT NULL

CONN_AUDIT (4600)

CONN_AUDIT_ID (PK)	NUMBER(10,0)	NOT NULL
STAFF_ID (FK)	NUMBER(10,0)	NOT NULL
AUDIT_DT	DATE	NOT NULL
ON_OFF	VARCHAR2(3)	NULL

MULTI_CNTY (4605)

MULTI_CNTY_ID (PK)	NUMBER(10,0)	NOT NULL
MULTI_CNTY_CD	CHAR(2)	NOT NULL
LAST_CHGD_BY	NUMBER(10,0)	NOT NULL
LAST_CHGD_DT	DATE	NOT NULL

MULTI_CNTY_DETAIL (4610)

MULTI_CNTY_DETAIL_ID (PK)	NUMBER(10,0)	NOT NULL
MULTI_CNTY_ID (FK)	NUMBER(10,0)	NOT NULL
CNTY_CD	CHAR(2)	NOT NULL
LAST_CHGD_BY	NUMBER(10,0)	NOT NULL
LAST_CHGD_DT	DATE	NOT NULL

(6,3)

PERSON_ILS_SVC (680)

PERSON_ILS_SVC_ID (PK)	NUMBER(10,0)	NOT NULL
PERSON_ILS_ID (FK)	NUMBER(10,0)	NOT NULL
SELF_SVC_CD	CHAR(1)	NULL
LAST_CHGD_BY	NUMBER(10,0)	NOT NULL
LAST_CHGD_DT	DATE	NOT NULL

PERSON_RELIGION (690)

PERSON_RELIGION_ID (PK)	NUMBER(10,0)	NOT NULL
PERSON_ID (FK)	NUMBER(10,0)	NULL
RELIGION_CD	CHAR(1)	NOT NULL
LAST_CHGD_BY	NUMBER(10,0)	NOT NULL
LAST_CHGD_DT	DATE	NOT NULL

CMHRS_CLIENT (4800)

CMHRS_CLIENT_ID (PK)	NUMBER(10,0)	NOT NULL
STATE_RPT_ID (FK)	NUMBER(10,0)	NOT NULL
PERSON_ID (FK)	NUMBER(10,0)	NOT NULL
NPI	VARCHAR2(10)	NULL
SSN	VARCHAR2(9)	NULL
PMI	VARCHAR2(10)	NULL
CNTY_OF_SVC_CD	CHAR(2)	NULL
CNTY_FIN_RESP_CD	CHAR(2)	NULL
BIRTH_DT	DATE	NULL
ESTIMATED_BIRTH_DT	DATE	NULL
GENDER_CD	CHAR(1)	NULL
CAUCASIAN_IND	VARCHAR2(1)	NULL
ASIAN_IND	VARCHAR2(1)	NULL
PACIFIC_IND	VARCHAR2(1)	NULL
BLACK_IND	VARCHAR2(1)	NULL
NORTH_AMER_IND	VARCHAR2(1)	NULL
HISPANIC_IND	VARCHAR2(1)	NULL
CMHRS_SUB_POP_CD	VARCHAR2(1)	NULL
HIGHLVL_DISABIL_CD	CHAR(2)	NULL
LAST_CHGD_BY	NUMBER(10,0)	NOT NULL
LAST_CHGD_DT	DATE	NOT NULL

INTAKE (1600)

INTAKE_ID (PK)	NUMBER(10,0)	NOT NULL
WG_ID (FK)	NUMBER(10,0)	NULL
INTAKE_TYPE_CD	CHAR(1)	NULL
INTAKE_METHOD_CD	CHAR(1)	NULL
STAFF_WARNING	BLOB	NULL
IN_PRES_PROB_CD	CHAR(2)	NULL
DESCR_OF_NEED	BLOB	NULL
INTAKE_COMMENTS	BLOB	NULL
IN_SOURCE_CD	VARCHAR2(2)	NULL
SOURCE_PERSON_ID (FK)	NUMBER(10,0)	NULL
LAST_CHGD_BY	NUMBER(10,0)	NOT NULL
LAST_CHGD_DT	DATE	NOT NULL

INTAKE_SNAPSHOT (1630)

INTAKE_SNAPSHOT_ID (PK)	NUMBER(10,0)	NOT NULL
INTAKE_ID (FK)	NUMBER(10,0)	NOT NULL
REPORT_ID (FK)	NUMBER(10,0)	NOT NULL
LAST_CHGD_BY	NUMBER(10,0)	NOT NULL
LAST_CHGD_DT	DATE	NOT NULL

CMHRS_SVC (4805)

CMHRS_SVC_ID (PK)	NUMBER(10,0)	NOT NULL
CMHRS_CLIENT_ID (FK)	NUMBER(10,0)	NOT NULL
BRASS_SVC_ID (FK)	NUMBER(10,0)	NOT NULL
TOT_REPORTED_MIN	NUMBER(10,0)	NULL
LAST_CHGD_BY	NUMBER(10,0)	NOT NULL
LAST_CHGD_DT	DATE	NOT NULL

DOCUMENTATION (315)

DOCUMENTATION_ID (PK)	NUMBER(10,0)	NOT NULL
WG_ID (FK)	NUMBER(10,0)	NULL
INTAKE_ID (FK)	NUMBER(10,0)	NULL
INCOMING_IND	CHAR(1)	NULL
RECEIVED_SENT_DT	DATE	NULL
FORMAT	VARCHAR2(30)	NULL
ORIGINATOR	VARCHAR2(60)	NULL
DOC_NAME	VARCHAR2(60)	NULL
DOCUMENTATION_DESC	VARCHAR2(180)	NULL
STORAGE_LOC	VARCHAR2(60)	NULL
CNTY_DOC_ID	VARCHAR2(20)	NULL
LAST_CHGD_BY	NUMBER(10,0)	NOT NULL
LAST_CHGD_DT	DATE	NOT NULL

CMHRS_SVC_OBO_XREF (4810)

CMHRS_SVC_OBO_XRF_ID (PK)	NUMBER(10,0)	NOT NULL
CMHRS_SVC_ID (FK)	NUMBER(10,0)	NOT NULL
ON_BEHALF_OF_ID (FK)	NUMBER(10,0)	NULL
GRP_TIME_IND	VARCHAR2(1)	NULL
REPORTED_MIN	NUMBER(10,0)	NULL
LAST_CHGD_BY	NUMBER(10,0)	NOT NULL
LAST_CHGD_DT	DATE	NOT NULL

PUSHPULL_LOG (2225)

PUSHPULLLOG_ID (PK)	NUMBER(10,0)	NOT NULL
LOGGED_DT	DATE	NOT NULL
SEVERITY	NUMBER(10,0)	NULL
SOURCE_CD	CHAR(1)	NULL
TRANS_ID	NUMBER(10,0)	NULL
MESSAGE	VARCHAR2(1000)	NULL
TRANS_CD	NUMBER(10,0)	NULL
ACT_CD	CHAR(1)	NULL

IMP_EXP_LOG (3110)

IMP_EXP_LOG_ID (PK)	NUMBER(10,0)	NOT NULL
IMP_EXP_LOG_DT	DATE	NULL
IMP_EXP_LOG_TYPE_CD	VARCHAR2(1)	NULL
IMP_EXP_LOG_STAT_CD	VARCHAR2(1)	NULL
IMP_EXP_LOG_MSG	VARCHAR2(400)	NULL
IMP_EXP_LOG_DATA	VARCHAR2(4000)	NULL

IVE_ABSTRACT_CNT (5105)

IVE_ABSTRACT_CNT_ID (PK)	NUMBER(10,0)	NOT NULL
STATE_RPT_ID (FK)	NUMBER(10,0)	NOT NULL
IVE_RPT_CNT_LINE_CD	VARCHAR2(2)	NOT NULL
IVE_RPT_CNT_TYPE_CD	VARCHAR2(2)	NOT NULL
LINE_CNT	NUMBER(10,0)	NULL
LINE_COUNT_DT	DATE	NOT NULL
LINE_ADJUSTMENT	NUMBER(10,0)	NULL
LAST_CHGD_BY	NUMBER(10,0)	NOT NULL
LAST_CHGD_DT	DATE	NOT NULL

IVE_CNT_PERS_XREF (5135)

IVE_CNT_PERS_XREF_ID (PK)	NUMBER(10,0)	NOT NULL
IVE_ABSTRACT_CNT_ID (FK)	NUMBER(10,0)	NOT NULL
PERSON_ID (FK)	NUMBER(10,0)	NOT NULL
LAST_CHGD_BY	NUMBER(10,0)	NOT NULL
LAST_CHGD_DT	DATE	NOT NULL

MESSAGE_GROUP (5125)

MESSAGE_GROUP_ID (PK)	NUMBER(10,0)	NOT NULL
MODULE_MESSAGE_ID (FK)	NUMBER(10,0)	NOT NULL
GROUP_LABEL	VARCHAR2(65)	NOT NULL
GROUP_DEFAULT_IND	VARCHAR2(1)	NULL
DISPLAY_ROW_NUM	NUMBER(3,0)	NOT NULL
DISPLAY_COL_NUM	NUMBER(3,0)	NULL
GROUP_VISIBLE_IND	VARCHAR2(1)	NULL
LAST_CHGD_BY	NUMBER(10,0)	NOT NULL
LAST_CHGD_DT	DATE	NOT NULL

MODULE_MESSAGE (5120)

MODULE_MESSAGE_ID (PK)	NUMBER(10,0)	NOT NULL
MODULE_CD	VARCHAR2(2)	NOT NULL
SUB_MODULE_CD	VARCHAR2(2)	NULL
MODULE_DETAIL_CD	VARCHAR2(2)	NULL
RECORD_TYPE_CD	VARCHAR2(2)	NULL
LAST_CHGD_BY	NUMBER(10,0)	NOT NULL
LAST_CHGD_DT	DATE	NOT NULL

MODULE_MESSAGE_XREF (5130)

MODULE_MSG_XREF_ID (PK)	NUMBER(10,0)	NOT NULL
MODULE_MESSAGE_ID (FK)	NUMBER(10,0)	NOT NULL
MESSAGE_GROUP_ID (FK)	NUMBER(10,0)	NULL
SSIS_MESSAGE_ID (FK)	NUMBER(10,0)	NOT NULL
ACTIVE_IND	CHAR(1)	NULL
IMAGE_NUM	NUMBER(10,0)	NULL
MSG_SEVERITY_CD	VARCHAR2(2)	NULL
MSG_NAV_HINT_CD	VARCHAR2(2)	NULL
MSG_XPATH	VARCHAR2(4000)	NULL
MSG_ACTION_CD	VARCHAR2(2)	NULL
SPEC_REF	NUMBER(10,5)	NULL
MSG_PREFIX_CD	VARCHAR2(2)	NULL
LAST_CHGD_BY	NUMBER(10,0)	NOT NULL
LAST_CHGD_DT	DATE	NOT NULL

IVE_ABSTRACT_CLM (5100)

IVE_ABSTRACT_CLM_ID (PK)	NUMBER(10,0)	NOT NULL
PERSON_ID (FK)	NUMBER(10,0)	NOT NULL
STATE_RPT_ID (FK)	NUMBER(10,0)	NOT NULL
PAYMENT_ID (FK)	NUMBER(10,0)	NOT NULL
CONTPLCMT_ID (FK)	NUMBER(10,0)	NULL
ORIG_IVE_CLM_ID (FK)	NUMBER(10,0)	NULL
SVC_BUS_ORG_ID (FK)	NUMBER(10,0)	NOT NULL
CLM_AMT	NUMBER(12,2)	NOT NULL
BEST_INTEREST_DT	DATE	NULL
CONTPLCMT_START_DT	DATE	NOT NULL
RULE_CD	VARCHAR2(3)	NOT NULL
IVE_SVC_TYPE_CD	VARCHAR2(2)	NOT NULL
PLACE_AUTH_CD	VARCHAR2(1)	NOT NULL
PROVIDER_CODE	VARCHAR2(11)	NOT NULL
PYMT_DT	DATE	NOT NULL
CLM_SVC_START_DT	DATE	NOT NULL
CLM_SVC_END_DT	DATE	NOT NULL
EXTENDED_ELIG_IND	VARCHAR2(1)	NULL
VOL_PLCMT_AGRMT_DT	DATE	NULL
AGE	NUMBER(5,0)	NULL
CLM_DOC_POINTS	NUMBER(3,0)	NULL
PROVIDER_TYPE_CD	VARCHAR2(1)	NOT NULL
RULE5_RB_IND	VARCHAR2(1)	NULL
LEGACY_IND	VARCHAR2(1)	NULL
LAST_CHGD_BY	NUMBER(10,0)	NOT NULL
LAST_CHGD_DT	DATE	NOT NULL

SSIS_MESSAGE (5115)

SSIS_MESSAGE_ID (PK)	NUMBER(10,0)	NOT NULL
SSIS_MSG_NUM	VARCHAR2(10)	NULL
MESSAGE_TEXT	VARCHAR2(400)	NULL
MSG_HELP_TEXT	VARCHAR2(4000)	NULL
LAST_CHGD_BY	NUMBER(10,0)	NOT NULL
LAST_CHGD_DT	DATE	NOT NULL

SYSTEM_ACT_PROFILE (4100)

SYS_ACT_PROFILE_ID (PK)	VARCHAR2(22)	NOT NULL
CNTY_CD	CHAR(2)	NULL
WORKSTATION_NAME	VARCHAR2(255)	NULL
SAP_USER_NAME	VARCHAR2(20)	NULL
ACTION_DT	DATE	NULL
ELAPSED_MSEC	NUMBER(12,3)	NULL
SAP_CATEGORY	VARCHAR2(30)	NULL
SAP_NAME	VARCHAR2(30)	NULL
SAP_METHOD	VARCHAR2(30)	NULL
SAP_PARAMS	VARCHAR2(4000)	NULL
CPU	VARCHAR2(40)	NULL
CPU_MHZ	NUMBER(8,0)	NULL
MEMORY_TOTAL_MB	NUMBER(8,0)	NULL
MEMORY_FREE_MB	NUMBER(8,0)	NULL
SERVER_IP	VARCHAR2(15)	NULL
SAP_VERSION	VARCHAR2(25)	NULL
PULLED_IND	VARCHAR2(1)	NULL
SAP_VIEW	VARCHAR2(4000)	NULL
OS_PLATFORM	VARCHAR2(4)	NULL
OS_VERSION	VARCHAR2(12)	NULL

CLM_RATE_ADJ (4535)

CLM_RATE_ADJ_ID (PK)	NUMBER(10,0)	NOT NULL
CLM_HEALTHCARE_ID (FK)	NUMBER(10,0)	NOT NULL
CLM_RATE_ADJ_INDEX	NUMBER(10,0)	NULL
CLM_RATE_ADJ_RSN_CD	VARCHAR2(2)	NULL
CLM_RATE_ADJ_RATE	NUMBER(12,2)	NULL
LAST_CHGD_BY	NUMBER(10,0)	NOT NULL
LAST_CHGD_DT	DATE	NOT NULL

CLM_EXCEPTION (4530)

CLM_EXCEPTION_ID (PK)	NUMBER(10,0)	NOT NULL
CLM_HEALTHCARE_ID (FK)	NUMBER(10,0)	NOT NULL
CLM_EXCEPTION_CD	VARCHAR2(4)	NULL
LAST_CHGD_BY	NUMBER(10,0)	NOT NULL
LAST_CHGD_DT	DATE	NOT NULL

CLM_REMIT_ADV_ADJ (4540)

CLM_REMIT_ADV_ADJ_ID (PK)	NUMBER(10,0)	NOT NULL
CLM_HEALTHCARE_ID (FK)	NUMBER(10,0)	NOT NULL
CLM_RA_ADJ_GRP_CD	VARCHAR2(2)	NULL
CLM_RA_ADJ_REASON_CD	VARCHAR2(3)	NULL
CLM_RA_ADJ_AMT	NUMBER(12,2)	NULL
CLM_RA_ADJ_UNITS	NUMBER(10,0)	NULL
LAST_CHGD_BY	NUMBER(10,0)	NOT NULL
LAST_CHGD_DT	DATE	NOT NULL

CLM_HEALTHCARE (4500)

CLM_HEALTHCARE_ID (PK)	NUMBER(10,0)	NOT NULL
ORIG_CLM_HEALTHCR_ID (FK)	NUMBER(10,0)	NULL
PERSON_ID (FK)	NUMBER(10,0)	NOT NULL
DIAGNOSIS_ID (FK)	NUMBER(10,0)	NULL
HCPCS_MOD_ID (FK)	NUMBER(10,0)	NULL
PMI	VARCHAR2(10)	NULL
CLAIM_CAT_CD	VARCHAR2(1)	NULL
CLM_STAT_CD	VARCHAR2(2)	NULL
CNTY_CD	CHAR(2)	NULL
CLM_AMT	NUMBER(12,2)	NOT NULL
MMIS_PLACE_SVC_CD	VARCHAR2(2)	NULL
MMIS_FREQ_CD	VARCHAR2(1)	NULL
CLM_UNITS	NUMBER(10,0)	NULL
PRIOR_AUTH_NUM	NUMBER(11,0)	NULL
CLM_START_DT	DATE	NULL
CLM_END_DT	DATE	NULL
FACILITY_NAME	VARCHAR2(40)	NULL
OUT_HOME_PROV_NUM	VARCHAR2(20)	NULL
TCN	VARCHAR2(17)	NULL
CLM_PAID_AMT	NUMBER(12,2)	NULL
CLM_GEN_DT	DATE	NULL
CLM_STAT_DT	DATE	NULL
CLM_PAID_UNITS	NUMBER(10,0)	NULL
NPI	VARCHAR2(10)	NULL
CLM_CLIENT_RESP_AMT	NUMBER(12,2)	NULL
CLAIM_CAT_DETAIL_CD	VARCHAR2(1)	NULL
CLM_DISPOSITION_CD	VARCHAR2(1)	NULL
CLM_DISPOSITION_DT	DATE	NULL
LAST_CHGD_BY	NUMBER(10,0)	NOT NULL
LAST_CHGD_DT	DATE	NOT NULL

CLM_BATCH (4505)

CLM_BATCH_ID (PK)	NUMBER(10,0)	NOT NULL
STAFF_ID (FK)	NUMBER(10,0)	NULL
CLM_BATCH_DESC	VARCHAR2(40)	NULL
CLM_INCL_TYPE_CD	VARCHAR2(1)	NULL
CNTY_CD	CHAR(2)	NULL
CLM_BATCH_START_DT	DATE	NULL
CLM_BATCH_END_DT	DATE	NULL
CLM_BATCH_GEN_DT	DATE	NULL
CLM_BATCH_SUB_DT	DATE	NULL
CLM_BATCH_STAT_CD	VARCHAR2(1)	NULL
CLAIM_CAT_CD	VARCHAR2(1)	NULL
ISA_CTRL_NUM	NUMBER(10,0)	NULL
DEX_837_ID (FK)	NUMBER(10,0)	NULL
DEX_997_ID (FK)	NUMBER(10,0)	NULL
LAST_CHGD_BY	NUMBER(10,0)	NOT NULL
LAST_CHGD_DT	DATE	NOT NULL

CLM_BATCH_XREF (4510)

CLM_BATCH_XREF_ID (PK)	NUMBER(10,0)	NOT NULL
CLM_BATCH_ID (FK)	NUMBER(10,0)	NOT NULL
CLM_HEALTHCARE_ID (FK)	NUMBER(10,0)	NOT NULL
LAST_CHGD_BY	NUMBER(10,0)	NOT NULL
LAST_CHGD_DT	DATE	NOT NULL

CLM_ON_BEHALF_XREF (4515)

CLM_ONBEHALF_XREF_ID (PK)	NUMBER(10,0)	NOT NULL
CLM_HEALTHCARE_ID (FK)	NUMBER(10,0)	NOT NULL
ON_BEHALF_OF_ID (FK)	NUMBER(10,0)	NULL
LAST_CHGD_BY	NUMBER(10,0)	NOT NULL
LAST_CHGD_DT	DATE	NOT NULL

CNTY_CLM_CONTROL (4525)

CNTY_CLM_CONTROL_ID (PK)	NUMBER(10,0)	NOT NULL
CNTY_CD	CHAR(2)	NULL
MMIS_PROV_NUM	VARCHAR2(10)	NULL
FED_TID	VARCHAR2(9)	NULL
NPI	VARCHAR2(10)	NULL
ISA_CTRL_NUM	NUMBER(10,0)	NULL
LAST_CHGD_BY	NUMBER(10,0)	NOT NULL
LAST_CHGD_DT	DATE	NOT NULL

CLM_PAYMENT_XREF (4520)

CLM_PAYMENT_XREF_ID (PK)	NUMBER(10,0)	NOT NULL
CLM_HEALTHCARE_ID (FK)	NUMBER(10,0)	NOT NULL
PAYMENT_ID (FK)	NUMBER(10,0)	NOT NULL
LAST_CHGD_BY	NUMBER(10,0)	NOT NULL
LAST_CHGD_DT	DATE	NOT NULL

IVE_RPT_CLAIM_FFHA (4030)

IVE_RPT_CLM_FFHA_ID (PK)	NUMBER(10,0)	NOT NULL
IVE_RPT_CLM_MAIN_ID (FK)	NUMBER(10,0)	NOT NULL
STATE_RPT_ID (FK)	NUMBER(10,0)	NOT NULL
DOC_POINTS	NUMBER(10,0)	NULL
EXP_PER_DIEM	NUMBER(10,2)	NULL
EXP_TOT_PYMT	NUMBER(10,2)	NULL
EXP_UNIT_RATE	NUMBER(10,2)	NULL
R4_PER_DIEM	NUMBER(10,2)	NULL
R4_TOT_RATE	NUMBER(10,2)	NULL
R4_APPR_INTK_PLN_PCT	NUMBER(10,2)	NULL
R4_APPR_TRNG_PCT	NUMBER(10,2)	NULL
LAST_CHGD_BY	NUMBER(10,0)	NOT NULL
LAST_CHGD_DT	DATE	NOT NULL

PROOFING (4040)

PROOFING_ID (PK)	NUMBER(10,0)	NOT NULL
STATE_RPT_ID (FK)	NUMBER(10,0)	NOT NULL
PROOF_SUB_CD	VARCHAR2(18)	NULL
PAYMENT_ID (FK)	NUMBER(10,0)	NULL
PERSON_ID (FK)	NUMBER(10,0)	NULL
PROOF_PATH	VARCHAR2(250)	NULL
PROOF_CAPTION	VARCHAR2(400)	NULL
PROOF_DESC	VARCHAR2(1000)	NULL
PROOF_GROUP_CAPTION	VARCHAR2(64)	NULL

CLM_COMMENT_XREF (4611)

CLM_COMMENT_XREF_ID (PK)	NUMBER(10,0)	NOT NULL
CLM_HEALTHCARE_ID (FK)	NUMBER(10,0)	NOT NULL
COMMENTS_LOG_ID (FK)	NUMBER(10,0)	NOT NULL
LAST_CHGD_BY	NUMBER(10,0)	NOT NULL
LAST_CHGD_DT	DATE	NOT NULL

ELIG_REV_ACCT (4555)

ELIG_REV_ACCT_ID (PK)	NUMBER(10,0)	NOT NULL
PERSON_ID (FK)	NUMBER(10,0)	NULL
CLM_REV_ACCT_ID (FK)	NUMBER(10,0)	NULL
WG_ID (FK)	NUMBER(10,0)	NULL
ELIG_REV_START_DT	DATE	NULL
ELIG_REV_END_DT	DATE	NULL
LAST_CHGD_BY	NUMBER(10,0)	NOT NULL
LAST_CHGD_DT	DATE	NOT NULL

CLM_REV_ACCT (4550)

CLM_REV_ACCT_ID (PK)	NUMBER(10,0)	NOT NULL
CLAIM_CAT_CD	VARCHAR2(1)	NULL
REV_ACCT_CODE	VARCHAR2(10)	NULL
REV_ACCT_DESC	VARCHAR2(65)	NULL
REV_ACCT_START_DT	DATE	NULL
REV_ACCT_END_DT	DATE	NULL
LAST_CHGD_BY	NUMBER(10,0)	NOT NULL
LAST_CHGD_DT	DATE	NOT NULL

TCM_CSR_CLIENT (4410)

TCM_CSR_CLIENT_ID (PK)	NUMBER(10,0)	NOT NULL
TCM_CSR_LINE_ID (FK)	NUMBER(10,0)	NOT NULL
PERSON_ID (FK)	NUMBER(10,0)	NULL
TCM_CSR_MONTH_CD	VARCHAR2(2)	NULL
RTC_HOST_CNTY_CD	VARCHAR2(2)	NULL
TCM_CSR_CLNT_INCL_CD	VARCHAR2(2)	NULL
LAST_CHGD_BY	NUMBER(10,0)	NOT NULL
LAST_CHGD_DT	DATE	NOT NULL

TCM_CSR_LINE (4405)

TCM_CSR_LINE_ID (PK)	NUMBER(10,0)	NOT NULL
STATE_RPT_ID (FK)	NUMBER(10,0)	NOT NULL
TCM_CSR_QTR_CD	VARCHAR2(1)	NULL
TCM_CSR_LINE_CD	VARCHAR2(2)	NULL
LAST_CHGD_BY	NUMBER(10,0)	NOT NULL
LAST_CHGD_DT	DATE	NOT NULL

TCM_CSR_STAT (4400)

TCM_CSR_STAT_ID (PK)	NUMBER(10,0)	NOT NULL
TCM_CSR_LINE_ID (FK)	NUMBER(10,0)	NOT NULL
TCM_CSR_VAL_TYPE_CD	VARCHAR2(2)	NULL
TCM_CSR_ADJ_TYPE_CD	VARCHAR2(2)	NULL
MONTH_1_CNT	NUMBER(10,0)	NULL
MONTH_2_CNT	NUMBER(10,0)	NULL
MONTH_3_CNT	NUMBER(10,0)	NULL
LAST_CHGD_BY	NUMBER(10,0)	NOT NULL
LAST_CHGD_DT	DATE	NOT NULL

VNIMPORT

VIKEY (PK)	NUMBER(10,0)	NOT NULL
VIVNO	VARCHAR2(20)	NOT NULL
VINAME	VARCHAR2(50)	NULL
VIADD1	VARCHAR2(100)	NULL
VIADD2	VARCHAR2(100)	NULL
VIADD3	VARCHAR2(100)	NULL
VICITY	VARCHAR2(25)	NULL
VIST	VARCHAR2(2)	NULL
VIZIP	VARCHAR2(9)	NULL
VIFSSN	VARCHAR2(9)	NULL
VIPHON	VARCHAR2(50)	NULL
VIFAX	VARCHAR2(50)	NULL
VIEMAL	VARCHAR2(100)	NULL
VISTAT	VARCHAR2(1)	NULL
VIPAYE	VARCHAR2(20)	NULL
VIMAIID	VARCHAR2(10)	NULL
VI1099	VARCHAR2(1)	NULL
VINPI	VARCHAR2(10)	NULL
VICNTY	VARCHAR2(2)	NULL
VIP_DT	DATE	NULL
VIR_CD	VARCHAR2(1)	NULL
VIA_CD	VARCHAR2(1)	NULL
VIDESC	VARCHAR2(200)	NULL

(6,7)

AP_RPT_DL_PHONE_XREF (4740)

AP_RPT_DL_PHNXREF_ID (PK)	NUMBER(10,0)	NOT NULL
AP_RPT_DIST_LIST_ID (FK)	NUMBER(10,0)	NOT NULL
PHONE_ID (FK)	NUMBER(10,0)	NOT NULL
PHONE_TYPE_CD	CHAR(1)	NULL
LAST_CHGD_BY	NUMBER(10,0)	NOT NULL
LAST_CHGD_DT	DATE	NOT NULL

AP_RPT_DIST_LIST (4735)

AP_RPT_DIST_LIST_ID (PK)	NUMBER(10,0)	NOT NULL
AP_RPT_ID (FK)	NUMBER(10,0)	NULL
INCLUDE_IND	VARCHAR2(1)	NULL
INCLUDE_CALLER_IND	VARCHAR2(1)	NULL
PRINTED_IND	VARCHAR2(1)	NULL
AP_DIST_LIST_CD	VARCHAR2(2)	NULL
APDL_NAME	VARCHAR2(256)	NULL
LAST_CHGD_BY	NUMBER(10,0)	NOT NULL
LAST_CHGD_DT	DATE	NOT NULL

Q\$ERROR_CONTEXT (4910)

Q\$ERROR_CONTEXT_ID (PK)	NUMBER(10,0)	NOT NULL
Q\$ERROR_INSTANCE_ID (FK)	NUMBER(10,0)	NULL
EC_NAME	VARCHAR2(500)	NOT NULL
EC_VALUE	VARCHAR2(4000)	NULL
CREATED_ON_DT	DATE	NULL
CREATED_BY	VARCHAR2(100)	NULL
CHANGED_ON_DT	DATE	NULL
CHANGED_BY	VARCHAR2(100)	NULL

DI_MMIS_PMI (3497)

PMI (PK)	VARCHAR2(10)	NOT NULL
LAST_CHGD_BY	NUMBER(10,0)	NULL
LAST_CHGD_DT	DATE	NOT NULL

Q\$ERROR_INSTANCE (4905)

Q\$ERROR_INSTANCE_ID (PK)	NUMBER(10,0)	NOT NULL
Q\$ERROR_ID (FK)	NUMBER(10,0)	NULL
ERROR_STACK	VARCHAR2(4000)	NULL
CALL_STACK	VARCHAR2(4000)	NULL
EI_MESSAGE	VARCHAR2(4000)	NULL
SYSTEM_ERROR_CODE	NUMBER(10,0)	NULL
SYSTEM_ERROR_MSG	VARCHAR2(4000)	NULL
ENVIRONMENT_INFO	VARCHAR2(4000)	NULL
CREATED_ON_DT	DATE	NULL
CREATED_BY	VARCHAR2(100)	NULL
CHANGED_ON_DT	DATE	NULL
CHANGED_BY	VARCHAR2(100)	NULL

TRANSMISS_ERROR (2250)

TRANSMISS_ERROR_ID (PK)	NUMBER(10,0)	NOT NULL
CNTY_CD	CHAR(2)	NULL
CREATED_DT	DATE	NULL
TRANS_CD	NUMBER(10,0)	NULL
SUB_CD	NUMBER(10,0)	NULL
ACT_CD	CHAR(1)	NULL
ERROR_TYPE_CD (FK)	VARCHAR2(4)	NULL
ERROR_TEXT	VARCHAR2(800)	NULL
STAFF_ID	NUMBER(10,0)	NULL
PERTINENT_DT_TYPE	VARCHAR2(30)	NULL
PERTINENT_DT	DATE	NULL
INCLUSION_DT	DATE	NULL
WG_ID	NUMBER(10,0)	NULL
PERSON_ID	NUMBER(10,0)	NULL
REPORT_ELEMENT	VARCHAR2(200)	NULL

Q\$ERROR (4900)

Q\$ERROR_ID (PK)	NUMBER(10,0)	NOT NULL
ERROR_CATEGORY_NAME	VARCHAR2(500)	NULL
CODE_NUM	NUMBER(10,0)	NULL
ERROR_NAME	VARCHAR2(500)	NULL
ERR_DESCRIPTION	VARCHAR2(4000)	NULL
SUBSTITUTE_STRING	VARCHAR2(4000)	NULL
RECOMMENDATION	VARCHAR2(4000)	NULL
CREATED_ON_DT	DATE	NULL
CREATED_BY	VARCHAR2(100)	NULL
CHANGED_ON_DT	DATE	NULL
CHANGED_BY	VARCHAR2(100)	NULL

TRANSMISS_ERR_TYPE (2270)

ERROR_TYPE_CD (PK)	VARCHAR2(4)	NOT NULL
ERROR_DESCRIPTION	VARCHAR2(100)	NULL
SCREEN	VARCHAR2(100)	NULL
LAST_CHGD_BY	NUMBER(10,0)	NOT NULL
LAST_CHGD_DT	DATE	NOT NULL

Q\$LOG (4915)

Q\$LOG_ID (PK)	NUMBER(10,0)	NOT NULL
CONTEXT	VARCHAR2(500)	NULL
QL_TEXT	VARCHAR2(4000)	NULL
CALL_STACK	VARCHAR2(4000)	NULL
CREATED_ON_DT	DATE	NULL
CREATED_BY	VARCHAR2(100)	NULL
CHANGED_ON_DT	DATE	NULL
CHANGED_BY	VARCHAR2(100)	NULL

TRANSMISS_STATUS (2255)

TRANSMISS_STAT_ID (PK)	NUMBER(10,0)	NOT NULL
RUN_COUNT	NUMBER(10,0)	NULL
PERCENT_ERRORS	NUMBER(10,0)	NULL
STATUS_TEXT	VARCHAR2(200)	NULL
LAST_CHGD_BY	NUMBER(10,0)	NOT NULL
LAST_CHGD_DT	DATE	NOT NULL

TRANSMISS_DEFERRED (2245)

TABLE_NAME (PK)	VARCHAR2(30)	NOT NULL
KEY (PK)	NUMBER	NOT NULL